

SELECTION GUIDE

POST TO POST

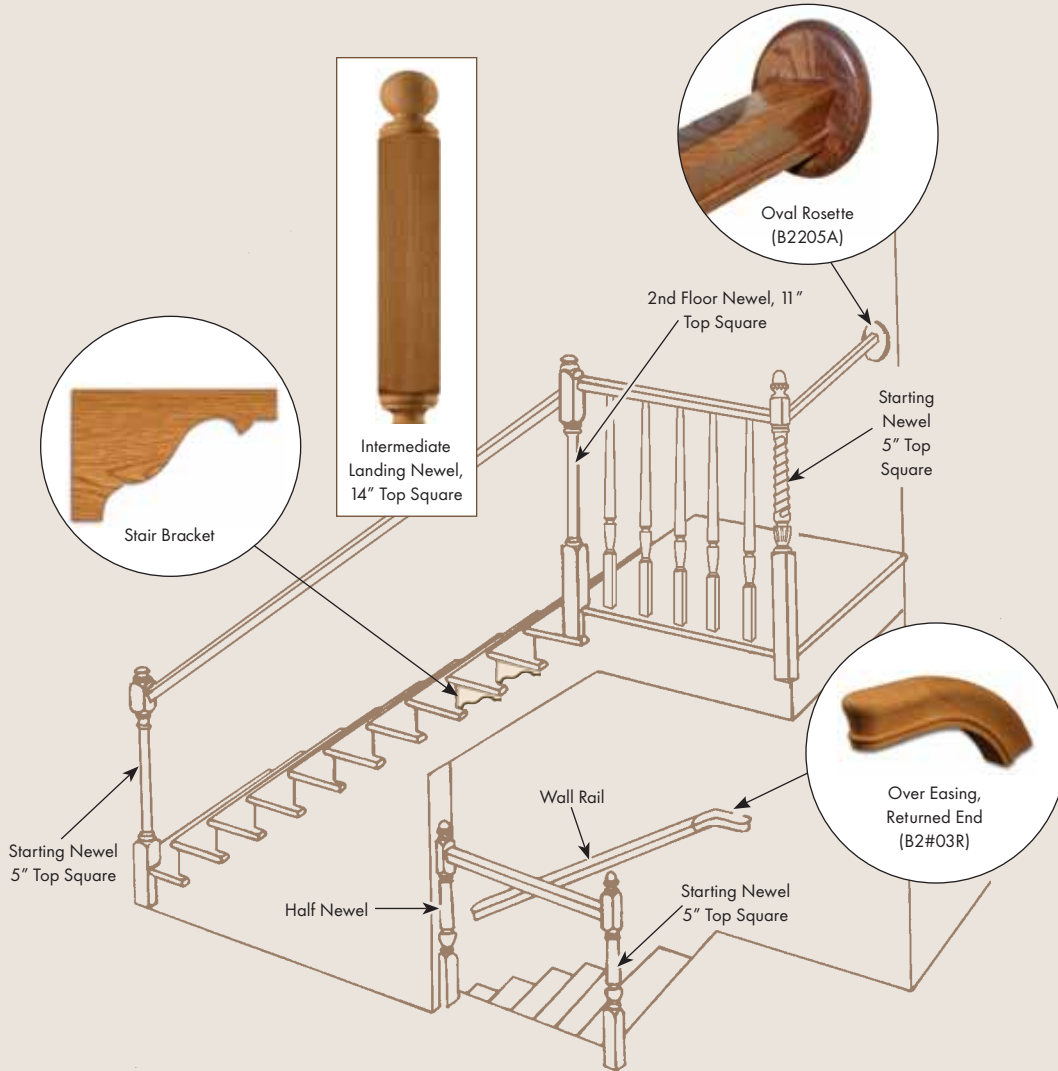

Post to Post Configurations



Starting Newel
no Fitting



Starting Newel
with Fitting



Landing Newel
(14" Square)
no Fitting



Angle Newel
(5" Square)
with Fitting



2nd Floor Newel
(11" Square)
no Fitting



Starting Newel
at 2nd Floor
(5" Square) with Fitting

Wood Specie Selection



Alder



Beech



Brazilian Cherry



Cherry



Hickory



Hard Maple



Mahogany

SELECTION GUIDE

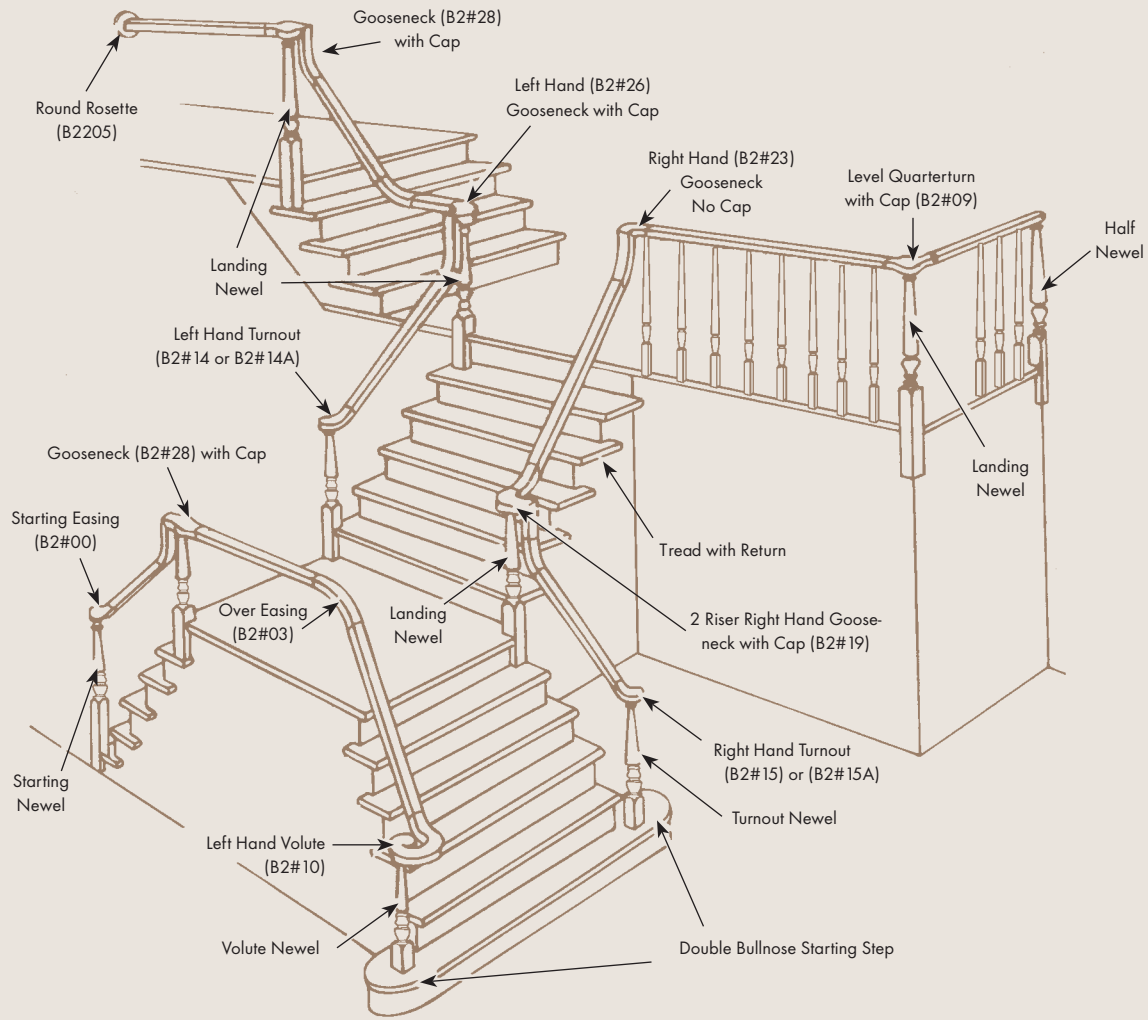

OVER THE POST

Handrail Fittings



LH Volute



LH Turnout



Starting Easing



Maple



Oak (Red)



Poplar

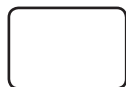

Prime



White



Walnut



White Oak

Handrails



B5000



B5100



B5200



B5208



B5226



B5310



B5400



B5500



B5700



B5900

BALUSTERS



ON • THE • LEVEL	B4205	B4241	B4305	B4341
ON • THE • RISE	B5015	B5141	-	-
Thickness (Square)	1 1/4"	1 1/4"	1 3/4"	1 3/4"

Options:
Fluting add -F
Reeded add -R

Fluted



B5015-F
B5141-F

Reeded



B5015-R
B5141-R



ON THE LEVEL™ Available Lengths:
31", 34", 36", 39",
and 42"

The height of the bottom square and the turned portion stays the same for all baluster heights. The turned portion is always parallel to the tread. Balusters are trimmed from the top.



ON THE RISE™ Available Lengths:
34", 38", and 42"

The bottom square becomes longer as the baluster height increases. The turned area is parallel to the rake (rise) of the stair. Balusters are trimmed from the bottom (loose dowel pin).

Bottom Rails



For rail specifications see page 52.

Over the Post

NEWELS

Newels	Height	B Turning Length	C Bottom Block	W Width
STARTING				
B3200A	43"	27"	15"	3"
B3201	48"	27"	20"	3"
LANDING				
B3210A	62"	27"	34"	3"
ANGLE (WINDER)				
B3227	72"	27"	44"	3"

VOLUTES/TURNOUTS

Newels	Height	B Turning Length	C Bottom Block	W Width
VOLUTE/TURNOUT (Adjustable)				
B3221C	48"	27"	14"	3"
VOLUTE (Use With Climbing Volute)				
B3221A	43"	27"	7 ³ / ₈ "	3"
TURNOUT (Old Code 30-34)				
B3222A	43"	27"	8 ¹ / ₂ "	3"

To use B3221A for code 34-38 specify a climbing volute -B2210CL, B2211CL, B2810CL, B2811CL



Post to Post

Posts	Height	A Top Block	B Turning Length	C Bottom Block	W Width
STARTING					
B3180	48"	5 ¹ / ₄ "	20 ³ / ₄ "	19 ¹ / ₂ "	3 ¹ / ₄ "
B3182	54"	5 ¹ / ₄ "	20 ³ / ₄ "	25 ¹ / ₂ "	3 ¹ / ₄ "
2ND FLOOR LANDING					
B3185	62"	11"	20 ³ / ₄ "	27 ³ / ₄ "	3 ¹ / ₄ "
INTERMEDIATE LANDING					
B3186	62"	14 ¹ / ₂ "	18"	27"	3 ¹ / ₄ "
ANGLE (WINDER)					
B3195	72"	5 ¹ / ₄ "	20 ³ / ₄ "	43 ¹ / ₂ "	3 ¹ / ₄ "



Starting newel w/fitting



Newels with an 11" top square are for 2nd floor landings when NOT using fittings. Balcony rail heights will be 36" when using this newel.



Starting newel no fitting



Angle newel w/fitting



Newels with an 14¹/₂" top square are for intermediate landings when NOT using fittings or for 2nd floor landings and balcony rail heights over 36".

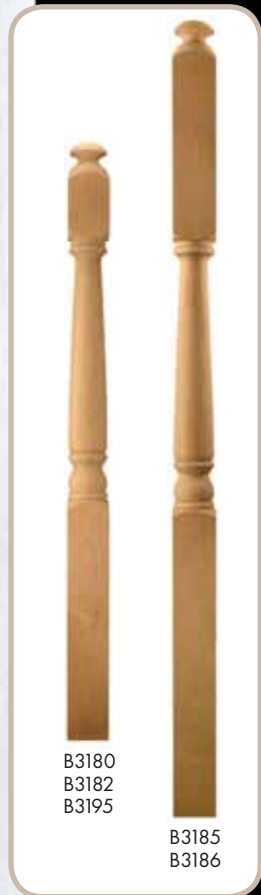

Handrails



B5000



B5100



B5200



B5208



B5226



B5310



B5400



B5500



B5700



B5900

BALUSTERS

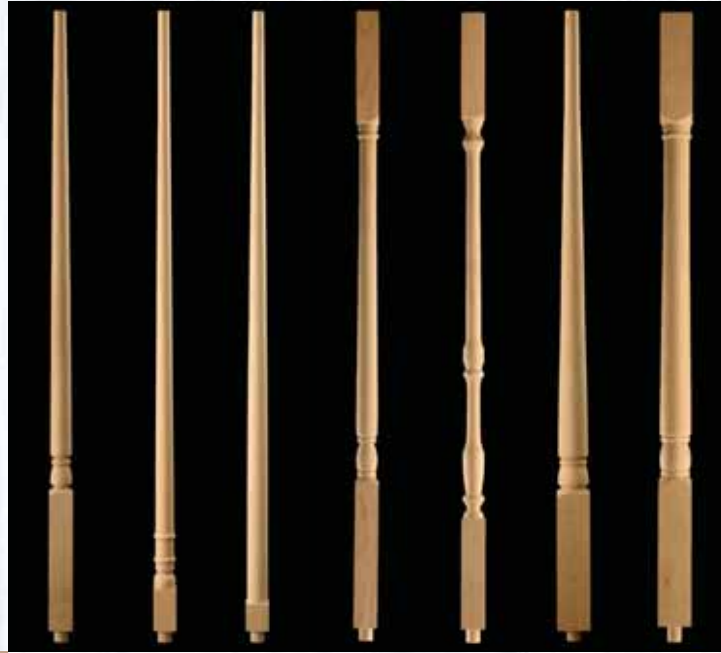

ON-THE-LEVEL	B4205	B4225	B4235	B4241	-	B4305	B4341
ON-THE-RISE	B5015	B5035	-	B5141	B5067	-	-
Thickness (Square)	1 1/4"	1 1/4"	1 1/4"	1 1/4"	1 1/4"	1 3/4"	1 3/4"

Options:
Fluting add -F
Reeded add -R

Fluted



B5015-F
B5035-F
B5141-F

Reeded



B5015-R
B5141-R



ON THE LEVEL™

Available Lengths:
31", 34", 36", 39",
and 42"

The height of the bottom square and the turned portion stays the same for all baluster heights. The turned portion is always parallel to the tread. Balusters are trimmed from the top.



ON THE RISE™

Available Lengths:
34", 38", and 42"

The bottom square becomes longer as the baluster height increases. The turned area is parallel to the rake (rise) of the stair. Balusters are trimmed from the bottom (loose dowel pin).

For rail specifications see page 52.

Bottom Rails

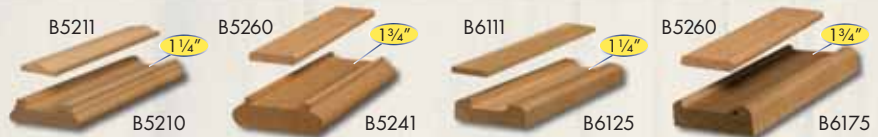

Over the Post

NEWELS

Newels	Height	B Turning Length	C Bottom Block	W Width
STARTING				
B3207A	43"	30 3/16"	11 13/16"	3"
LANDING				
B3217A	62"	30 3/16"	30 13/16"	3"
ANGLE (WINDER)				
B3218A	72"	30 9/16"	40 13/16"	3"

VOLUTES/TURNOUTS

Newels	Height	B Turning Length	C Bottom Block	W Width
VOLUTE/TURNOUT (Code 34-38)				
B3260C	48"	30 1/8"	9"	2 3/4"
VOLUTE (Use With Climbing Volute)				
B3205	43"	28 1/4"	5 7/8"	2 1/4"
B3260	43"	30 1/8"	4"	2 3/4"
TURNOUT (Old Code 30-34)				
B3206	44"	28 1/8"	9 3/8"	2 1/4"
B3261	43"	31 3/4"	4"	2 3/4"

To use B3205 or B3260 for code 34-38 specify a climbing volute - B2210CL, B2211CL, B2810CL, B2811CL



Post to Post

PLAIN

Posts	Ball Top Posts	Height	A Top Block	B Turning Length	C Bottom Block	W Width
STARTING						
B3240	B3204	48"	5"	23 1/4"	17"	3"
B3241	B3211	54"	5"	23 1/4"	23"	3"
	B3242	48"	N/A	N/A	N/A	3"
2ND FLOOR LANDING						
B3245	B3214	62"	11"	23 1/4"	26 1/4"	3"
B3244	-	62"	11"	18 1/4"	32 3/4"	3"
INTERMEDIATE LANDING						
B3246	B3213	62"	14 1/2"	18 1/4"	28 1/4"	3"
ANGLE (WINDER)						
B3255	B3215	72"	5"	23 1/4"	41"	3"

BALL TOP

Enhance Your Newels
Upgrade your newels from 3" to 4" thick.



Yellow numbers denote available in enhanced models.

Handrails



B5000



B5100



B5200



B5208



B5226



B5310



B5400



B5500



B5700



B5900

BALUSTERS

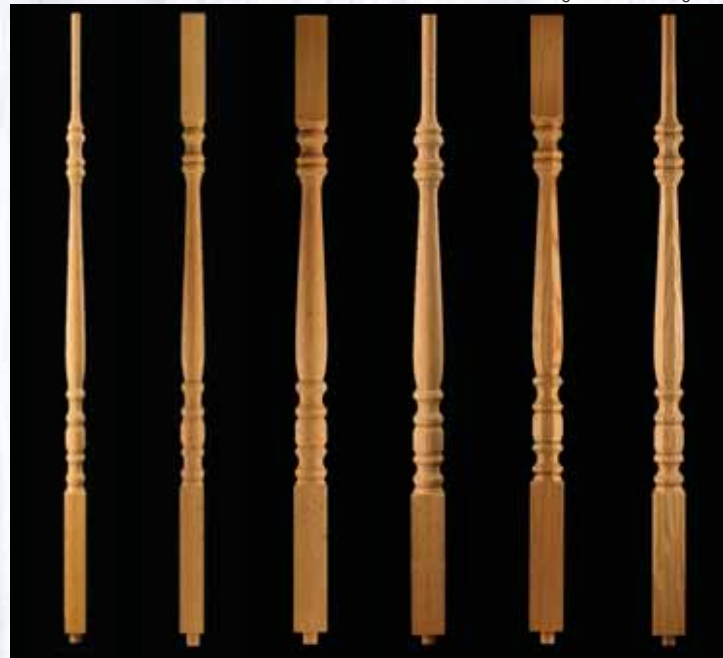

ON · THE · LEVEL	B4230	-	B4266	B4275	B4766	B4775
ON · THE · RISE	B5030	B5070	B4265*	B5300	B4265-8	B5300-8
Thickness (Square)	1 1/4"	1 1/4"	1 3/4"	1 3/4"	1 3/4"	1 3/4"

B4266 and B4275 may be ordered in 2" thickness: specify B4366 and B4375.



ON THE LEVEL™ Available Lengths: 31", 34", 36", 39", and 42"

The height of the bottom square and the turned portion stays the same for all baluster heights. The turned portion is always parallel to the tread. Balusters are trimmed from the top.



ON THE RISE™ Available Lengths: 34", 38", and 42"
* (B4265 balusters also available in 30" and 36" for stringer applications)

The bottom square becomes longer as the baluster height increases. The turned area is parallel to the rake (rise) of the stair. Balusters are trimmed from the bottom (loose dowel pin).

Options:
Fluting add -F

Fluted



B4265-F
B5300-F
B5030-F
B5070-F



DIVIDER SPINDLE

-Available in 1 3/4" x 48"

B4265-48

Bottom Rails

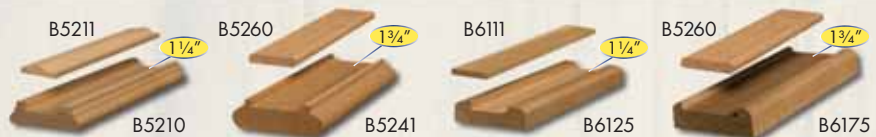

For rail specifications see page 52.

Over the Post

NEWELS

VOLUTES/TURNOUTS

Newels	Newels (Octagon)	Height	B Turning Length	C Bottom Block	W Width
STARTING					
B3298	-	43"	25 ³ / ₄ "	16 ¹ / ₄ "	3 ¹ / ₄ "
B3298C	B3798C	48"	25 ³ / ₄ "	21 ³ / ₄ "	3 ¹ / ₄ "
LANDING					
B3296	B3796	62"	25 ³ / ₄ "	35 ¹ / ₄ "	3 ¹ / ₄ "
VOLUTE/TURNOUT (Code 34-38)					
B3294C	B3794C	48"	28"	12 ¹ / ₈ "	3 ¹ / ₄ "
VOLUTE (Use With Climbing Volute)					
B3294	-	43"	24 ⁷ / ₈ "	8 ⁵ / ₈ "	3 ¹ / ₄ "
TURNOUT (Old Code 30-34)					
B3297	-	43"	25 ⁷ / ₈ "	9 ¹ / ₂ "	3 ¹ / ₄ "

To use B3294 for code 34-38 specify a climbing volute
-B2210CL, B2211CL, B2810CL, B2811CL

Yellow numbers denote available in enhanced models.

Enhance Your Newels

Upgrade your newels from 3¹/₄" to 3³/₄" thick.



Post to Post

PLAIN

OCTAGON

Posts	Posts (Octagon)	Height	A Top Block	B Turning Length	C Bottom Block	W Width
STARTING						
B3289	-	48"	-	-	-	3 ¹ / ₂ "
B3292	B3792	48"	6 ¹ / ₂ "	17 ¹ / ₂ "	20 ¹ / ₈ "	3 ¹ / ₂ "
B3299	B3799	56"	6 ¹ / ₂ "	17 ¹ / ₂ "	28 ¹ / ₈ "	3 ¹ / ₂ "
2ND FLOOR LANDING						
B3290	-	56"	-	-	-	3 ¹ / ₂ "
B3293	B3793	56"	11"	17 ¹ / ₂ "	23 ³ / ₄ "	3 ¹ / ₂ "
INTERMEDIATE LANDING						
B3291	-	72"	-	-	-	3 ¹ / ₂ "
B3295	B3795	72"	14 ¹ / ₂ "	17 ¹ / ₂ "	20 ¹ / ₈ "	3 ¹ / ₂ "

Yellow numbers denote available in enhanced models.

- AC (suffix)
Spade Top
- COL (suffix)
Colonial Top
- RT (suffix)
Round Top

Available post tops for B3289, B3290, B3291. Include the suffix after the model number when ordering.

Enhance Your Newels

Upgrade your posts from 3¹/₂" to 4¹/₂" thick.

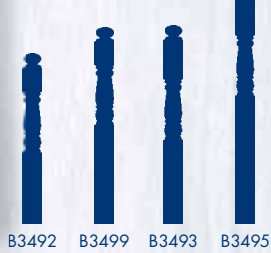

Newels may be ordered 3" thick (example: B3292-030)

Handrails



B5100



B5208



B5226



B5310



B5400



B5700



B5900

BALUSTERS

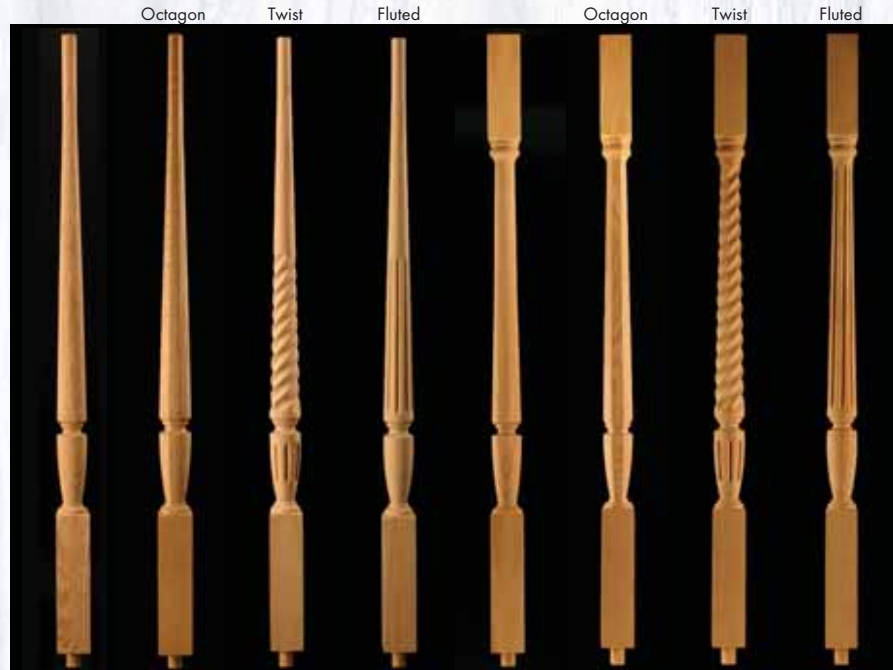

ON - THE - LEVEL	B4575	B4675	B4875	B4975	B4565	B4665	B4865	B4965
ON - THE - RISE	B2015-P	B2015-8	B2015-T	B2015-F	B2005-P	B2005-8	B2005-T	B2005-F
Thickness (Square)	1 3/4"	1 3/4"	1 3/4"	1 3/4"	1 3/4"	1 3/4"	1 3/4"	1 3/4"



ON THE LEVEL™ Available Lengths: 31", 34", 36", 39", and 42"

The height of the bottom square and the turned portion stays the same for all baluster heights. The turned portion is always parallel to the tread. Balusters are trimmed from the top.



ON THE RISE™ Available Lengths: 34", 38", and 42"

The bottom square becomes longer as the baluster height increases. The turned area is parallel to the rake (rise) of the stair. Balusters are trimmed from the bottom (loose dowel pin).

Bottom Rails

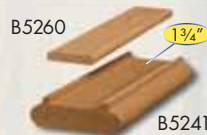

For rail specifications see page 52.

Over the Post

NEWELS

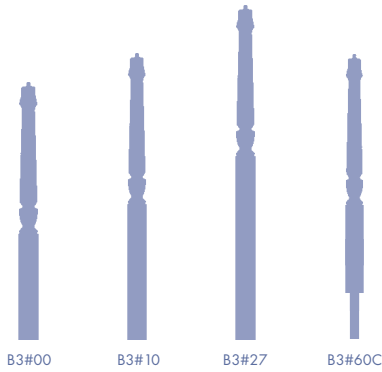

Plain Newels	Octagon Newels	Twist Newels	Fluted Newels	Height	B Turning Length	C Bottom Block	W Width
STARTING							
B3500	B3600	B3800	B3900	43"	27"	15"	3½"
B3500C	B3600C	B3800C	B3900C	48"	27"	20"	3½"
LANDING							
B3510	B3610	B3810	B3910	56"	27"	28"	3½"
ANGLE (WINDER)							
B3527	B3627	B3827	B3927	72"	27"	44"	3½"
VOLUTE/TURNOUT (Code 34-38) - ADJUSTABLE							
B3560C	B3660C	B3860C	B3960C	48"	27¼"	127/8"	3½"

VOLUTES/TURNOUTS



Octagon Twist Fluted



B35## series B36## series B38## series B39## series

Post to Post

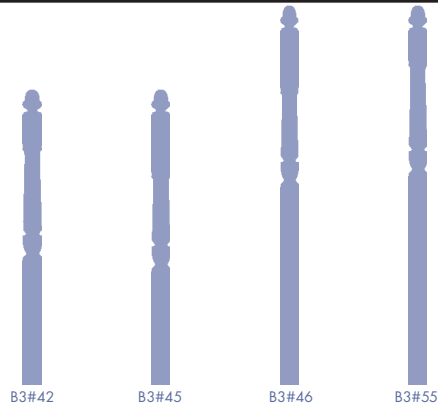

Posts	Octagon Posts	Twist Posts	Fluted Posts	Height	A Top Block	B Turning Length	C Bottom Block	W Width
STARTING								
B3542	B3642	B3842	B3942	56"	5"	23"	22"	3½"
2ND FLOOR LANDING								
B3545	B3645	B3845	B3945	56"	11"	18"	22"	3½"
INTERMEDIATE LANDING								
B3546	B3646	B3846	B3946	72"	14"	18"	35"	3½"
B3555	B3655	B3855	B3955	72"	5"	23"	39½"	3½"

Top Blocks



Octagon Twist Fluted



B3542 B3642 B3842 B3942
 B3545 B3645 B3845 B3945
 B3546 B3646 B3846 B3946
 B3555 B3655 B3855 B3955

BALUSTERS

Handrails



B5000



B5100



B5200



B5208



B5226



B5310



B5400



B5500



B5700



B5900



B1075
1 1/4" Sq

B1275
1 1/4" Sq

B1375
1 1/4" Sq

B1175
1 3/4" Sq

B1475
1 3/4" Sq

B1575
1 3/4" Sq

B1265
1 1/4" Sq

B1365
1 1/4" Sq

B1465
1 3/4" Sq

B1565
1 3/4" Sq



ON THE RISE™

Available Lengths:
34", 38", and 42"

Options:
Fluting add -F

Fluted



B1465-F
B1475-F

Bottom Rails



B5211

1 1/4"

B5210

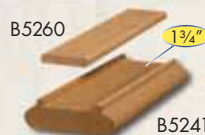

B5260

1 3/4"

B5241



B6111

1 1/4"

B6125



B5260

1 3/4"

B6175

For rail specifications see page 52.

Over the Post

NEWELS

VOLUTES/TURNOUTS

Newsels	Newsels (Reeded)	Height	B Turning Length	C Bottom Block	W Width
STARTING					
B3001	B3101	50"	23"	26"	3 1/2"
LANDING					
B3010	B3110	58"	23"	34"	3 1/2"
ANGLE (WINDER)					
B3027	B3127	72"	23"	48"	3 1/2"
VOLUTE/TURNOUT (ADJUSTABLE)					
B3021	B3121	48"	23"	14"	3 1/2"

Newels may be ordered 3" thick (example: B3001-030)



Reeded Newel

Reeded

B3021

Reeded

B3121

Reeded

B3001
B3010
B3027

Reeded

B3101
B3110
B3127

Post to Post

PLAIN

REEDED

Posts	Posts (Reeded)	Height	A Top Block	B Turning Length	C Bottom Block	W Width
STARTING						
B3040	B3140	48"	5"	23"	14 1/2"	3 1/2"
2ND FLOOR LANDING						
B3045	B3145	58"	11"	23"	22"	3 1/2"
INTERMEDIATE LANDING						
B3046	B3146	72"	14"	23"	36 1/2"	3 1/2"
B3055	B3155	72"	5"	23"	39 1/2"	3 1/2"

Newels may be ordered 3" thick (example: B3040-030)

Top Blocks

B3#40

B3#45

B3#46

Reeded

B3040
B3045
B3046
B3055

B3140
B3145
B3146
B3155

CONTEMPORARY SERIES

Rails



B5235



B5255



B5275



B5285



B6100



B6100P

BALUSTERS

Chamfered Fluted Chamfered & Fluted Chamfered & Grooved Chamfered, Fluted & Grooved Fluted & Grooved 6 V-Grooved 9 V-Grooved

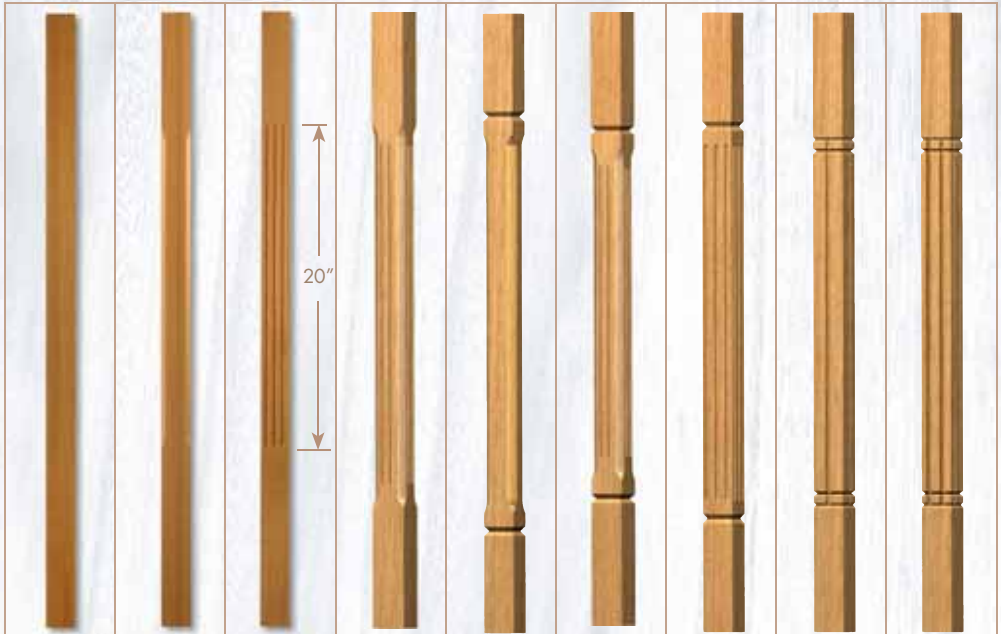

Thickness

1 1/4"	B4245	B4245-C	B4245-F	B4245-CF	B4245-CG	B4245-CFG	B4245-FG	-	-
1 1/2"	B4250	-	-	-	-	-	-	-	-
1 3/4"	B4255	B4255-C	B4255-F	B4255-CF	B4255-CG	B4255-CFG	B4255-FG	B4255-6P	B4255-9P

Bevel Top Newels

Height

Newels	Height	Width
STARTING		
B4000	48"	3 1/2"
B4002	48"	4"
2ND FLOOR LANDING & ANGLE		
B4001	56"	3 1/2"
B4003	56"	4"

Newels may be ordered 3" thick (example: B4000-030)

Chamfered Fluted Chamfered, Fluted & Grooved

B4000
B4001
B4002
B4003

B4000-C
B4001-C

B4000-F
B4001-F

B4000-CFG

NOTE: Most newels are available with the same milling options as the balusters.

Bottom Rails



For rail specifications see page 52.

Series 3

3 1/8"
6 1/4"
66 3/4"
57 7/8"
53"
24"
3 1/2" Sq
5" Sq

B7201
B7201 ADJ Adjustable

Series 4 Use with any Baluster Style

7 3/8"
24 9/16"
62"
30 1/16"
4 1/2" Sq

6 V-Grooved
9 V-Grooved
Fluted
Flat Panel
Raised Panel

B7092
B7092-6P
B7092-9P
B7094
B7095-FP
B7095-RP

Series 6 Use with any Baluster Style

9"
23"
55"
23"
6 1/4" Sq

6 V-Grooved
9 V-Grooved
Fluted
Flat Panel
Raised Panel

B7203
B7203-6P
B7203-9P
B7204
B7205-FP
B7205-RP
B7206

Removable Wood Panels (shown with Iron Insert Package)

Series 6 Box Newels include both Peak and Flat Caps.

The **B7206** (6 1/4" W x 5" L) is available in Red Oak, Poplar, Hard Maple, Cherry and Alder. Each newel includes: removable flat wood panels and loose stops. Order separately our iron insert packets in your choice of seven finishes (pyramid iron cap included) or create your own inserts: including iron, wood, or glass.

MORE BOX NEWELS ON THE NEXT PAGE.

Series 7 Use with any Baluster Style

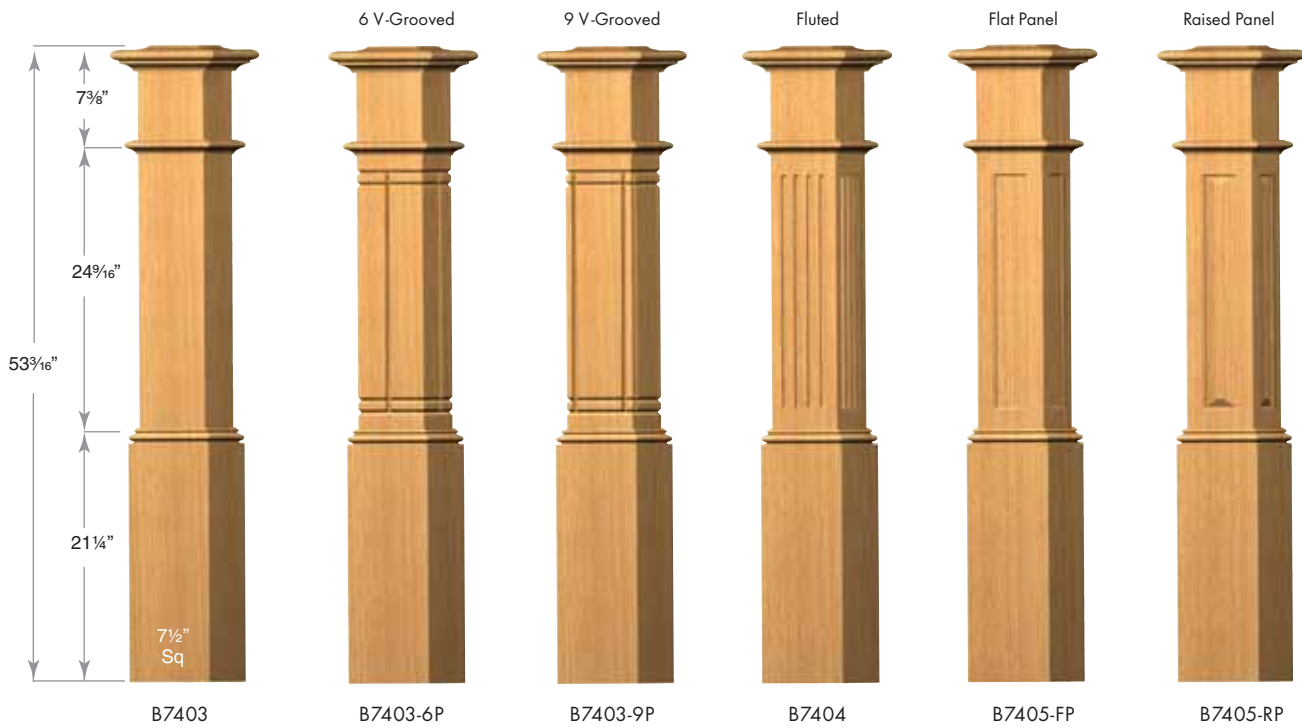

Mixed Specie

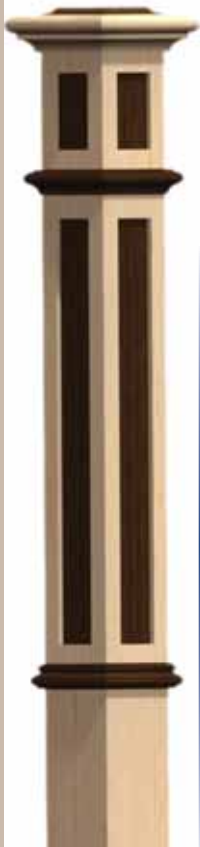

- 1 Main newel with raised or flat panels in a different specie.
- 2 Main newel with a cap in a different specie.
- 3 Main newel with molding in a different specie.

Top Block Panels Options

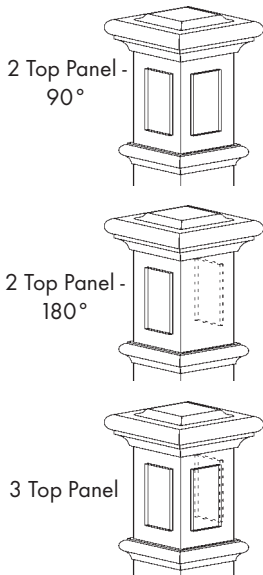

Custom Box Newels



Series 4, 6 or 7 can be customized for your building project.

- Add panels below the cap and above the top moulding. The panels can be on two or three sides. (your choice of which sides).
- Mix your species. The panels can have one specie and the box newel can be of another. The moulding and cap can either match the panel or the box newel specie.
- The sticking around the panels can be Shaker Style (square) or Colonial (round)

The panel between the mouldings can be divided into two or more panels.

Shown with 2 panels per side



All of our box newel panels are standard with Round Sticking ... order optional Square Sticking.



EZ Mount Base Block System

EZ-01 kit is available for Series 6 (included) and Series 7 (option) Box Newels. Includes base block, lag screws and washers.

The new premium Limited Reserve Collection was created to suit your signature style with a combination of classic and modern designs. The Country Woods Series features clean lines and a modern look.

ON THE RISE™
BALUSTERS

Fluted

CW15 CWE15-F

Thickness	1 3/4"
Available Lengths	34", 38", and 42"



ON THE RISE™

Available Lengths:
34", 38", and 42"

The bottom square becomes longer as the baluster height increases. The turned area is parallel to the rake (rise) of the stair. Balusters are trimmed from the bottom (loose dowel pin).

Over the Post

NEWELS Pin

VOLUTES/TURNOUTS Pin

Bottom Pin

Newels	Height	B Turning Length	W Width
STARTING			
CW74	50"	49"	3 1/2"
LANDING			
CW75	58"	57"	3 1/2"
ANGLE (WINDER)			
CW78	73"	72"	3 1/2"
VOLUTE/TURNOUT (Adjustable)			
CW60C	50"	ADJ	3 1/2"

Fluted

CW74 CWE74-F
CW75 CWE75-F
CW78 CWE78-F

Post to Post

Finial

Ball Top Posts

Ball Top Posts	Height	A Top Block	B Turning Length	W Width
STARTING				
CW80	48"	5"	39"	3 1/2"
CW82	58"	5"	49"	3 1/2"
CW93	62"	5"	53"	3 1/2"
CW95	73"	5"	64"	3 1/2"
CW98	78"	5"	69"	3 1/2"
2ND FLOOR LANDING				
CW85	58"	11"	43"	3 1/2"
INTERMEDIATE LANDING				
CW86	73"	14 1/2"	54 1/2"	3 1/2"

Fluted

CW80 CW80-F
CW82 CW82-F
CW85 CW85-F
CW86 CW86-F

The new premium Limited Reserve Collection was created to suit your signature style with a combination of classic and modern designs. The Byron Series focuses on a center ball detail and is offered in two unique versions: the standard and Euro styles.

Euro style

Euro style

Handrails



B5100



B5208



B5226



B5310



B5400



B5700



B5900

BALUSTERS

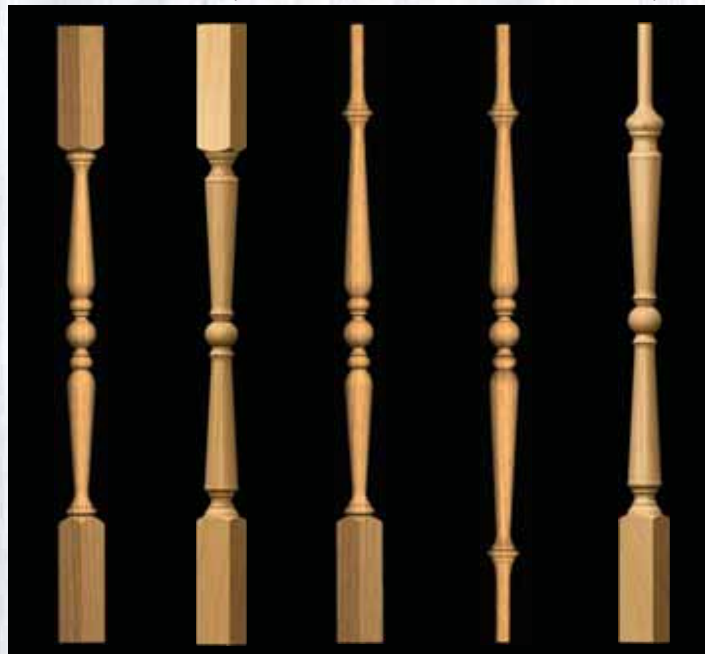

ON-THE-RISE

Thickness (Square)

BY05

BY06

BY15

BY25

BY26

1 3/4"

2"

1 3/4"

1 3/4"

2"



ON THE RISE™

Available Lengths:

BY25: 31", 34", 36", 39", 42"

BY05, BY15, BY25, BY26:

34", 38", 42"

The bottom square becomes longer as the baluster height increases. The turned area is parallel to the rake (rise) of the stair. Balusters are trimmed from the bottom (loose dowel pin). NOTE: When the BY25 is used for a balcony application then specify BY25-36B, BY25-39B & BY25-42B (turnings centered on balcony balusters).

Options:
Reeded Ball
add -RB

Decorative



BY##-RB

Options:
Pineapple Ball
add -PB

Decorative



BY##-PB

Rounded



Round
Top and
Bottom
Blocks
Available

Bottom
Rails

B5260

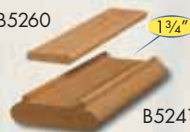

B5241

B5260



B6175

B5262



B6120

For rail
specifications
see page 52.

Over the Post

NEWELS

Pin
B
C
W

Euro
Euro
Euro
Euro
Euro
Euro

Newels	Height	B Turning Length	C Bottom Block	W Width
STARTING				
BY74	50"	27"	22"	3 1/2"
BYE74	50"	27"	22"	3 1/2"
LANDING				
BY75	58"	27"	30"	3 1/2"
BYE75	58"	27"	30"	3 1/2"
ANGLE (WINDER)				
BY78	73"	27"	45"	3 1/2"
BYE78	73"	27"	45"	3 1/2"

VOLUTES/TURNOUTS

Pin
B
C
Bottom Pin
W

Euro
Euro

Newels	Height	B Turning Length	C Bottom Block	W Width
VOLUTE/TURNOUT (Adjustable)				
BY60C	50"	27"	ADJ	3 1/2"
BYE60C	50"	27"	ADJ	3 1/2"



Post to Post

Options:
Reeded Ball Top
and Center Ball
add -RB

Decorative



BY##-RB

Finial
A
B
C
W

BY80
BY82
BY85
BY86
BY93
BY95
BY98

Ball Top Posts	Height	A Top Block	B Turning Length	C Bottom Block	W Width
STARTING					
BY80	48"	5"	24"	15"	3 1/2"
BYE80	48"	5"	21 3/4"	16 3/4"	3 1/2"
BY82	58"	5"	24"	25"	3 1/2"
BYE82	58"	5"	21 3/4"	26 3/4"	3 1/2"
BY93	62"	5"	24"	29"	3 1/2"
BYE93	62"	5"	21 3/4"	30 3/4"	3 1/2"
BY95	73"	5"	24"	40"	3 1/2"
BYE95	73"	5"	21 3/4"	41 3/4"	3 1/2"
BY98	78"	5"	24"	45"	3 1/2"
BYE98	78"	5"	21 3/4"	46 3/4"	3 1/2"
2ND FLOOR LANDING					
BY85	58"	11"	19 1/2"	23 1/2"	3 1/2"
BYE85	58"	11"	19 3/4"	22 3/4"	3 1/2"
INTERMEDIATE LANDING					
BY86	73"	14 1/2"	16"	38 1/2"	3 1/2"
BYE86	73"	14 1/2"	16 3/4"	37 1/4"	3 1/2"

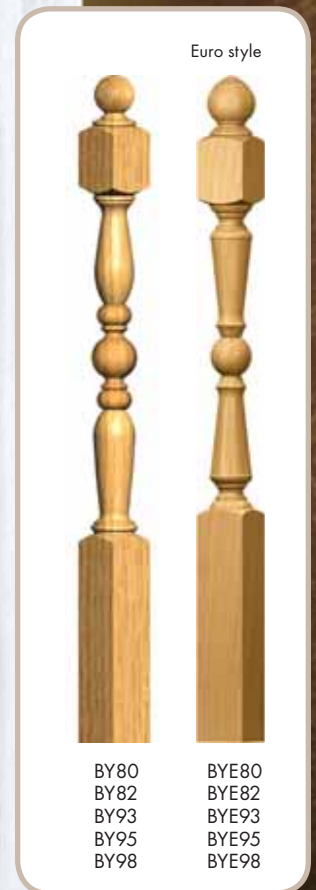

The new premium Limited Reserve Collection was created to suit your signature style with a combination of classic and modern designs. The Malvern Series features a variety of some of our newest and unique milling options.

Open Flute 2 Ribbon Square Open Flute 2 Ribbon Square

Handrails



B5100



B5208



B5226



B5310



B5400



B5700



B5900

BALUSTERS

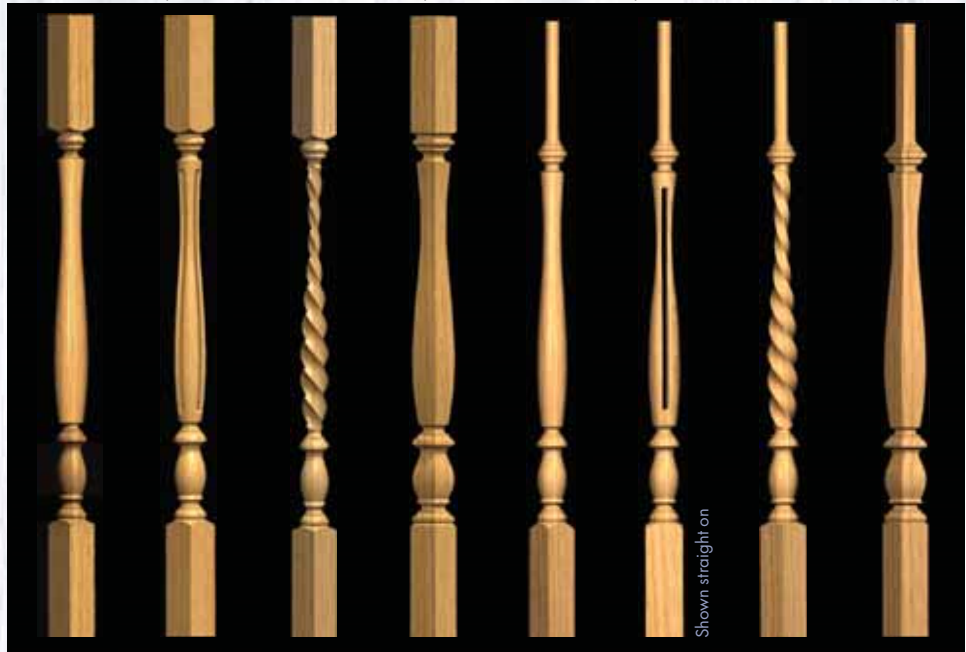

ON • THE • RISE	MV05	MV05-OPEN-F	MV05-2RIB	MV05-SQ	MV15	MV15-OPEN-F	MV15-2RIB	MV15-SQ
Thickness (Square)	1 3/4"	2"	1 3/4"	1 3/4"	1 3/4"	2"	1 3/4"	1 3/4"



ON THE RISE™

Available Lengths:
34", 38", and 42"

The bottom square becomes longer as the baluster height increases. The turned area is parallel to the rake (rise) of the stair. Balusters are trimmed from the bottom (loose dowel pin).



Bottom Rails

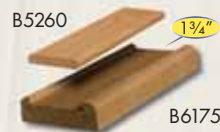
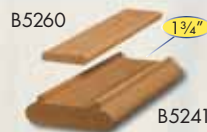

For rail specifications see page 52.

Over the Post

NEWELS

Newels	Height	B Turning Length	C Bottom Block	W Width
STARTING				
MV74	48"	23"	24"	3/4"
LANDING				
MV75	60"	23"	36"	3/4"
ANGLE (WINDER)				
MV78	73"	23"	49"	3/4"
VOLUTE/TURNOUT (Adjustable)				
MV60C	48"	23"	ADJ	3/4"

VOLUTES/TURNOUTS

Open Flute
Ribbon 2
Square

MV74
MV75
MV78

MV74-OPEN-F
MV75-OPEN-F
MV78-OPEN-F

MV74-2RIB
MV75-2RIB
MV78-2RIB

MV74-SQ
MV75-SQ
MV78-SQ

Post to Post

Finial

Posts	Height	A Top Block	B Turning Length	C Bottom Block	W Width
STARTING					
MV80	48"	6 3/4"	23"	14 1/2"	3/4"
MV82	54"	6 3/4"	23"	20 1/2"	3/4"
2ND FLOOR LANDING					
MV85	60"	10 1/4"	19 1/2"	26 1/2"	3/4"
INTERMEDIATE LANDING					
MV86	60"	13 1/4"	16"	27"	3/4"

Open Flute
Ribbon 2
Square

MV80
MV82

MV80-OPEN-F
MV82-OPEN-F

MV80-2RIB
MV82-2RIB

MV80-SQ
MV82-SQ

The new premium Limited Reserve Collection was created to suit your signature style with a combination of classic and modern designs. The Mercer Series is a sleek modern design that incorporates a decorative ball at the bottom block.

1 Twist

1 Twist

BALUSTERS

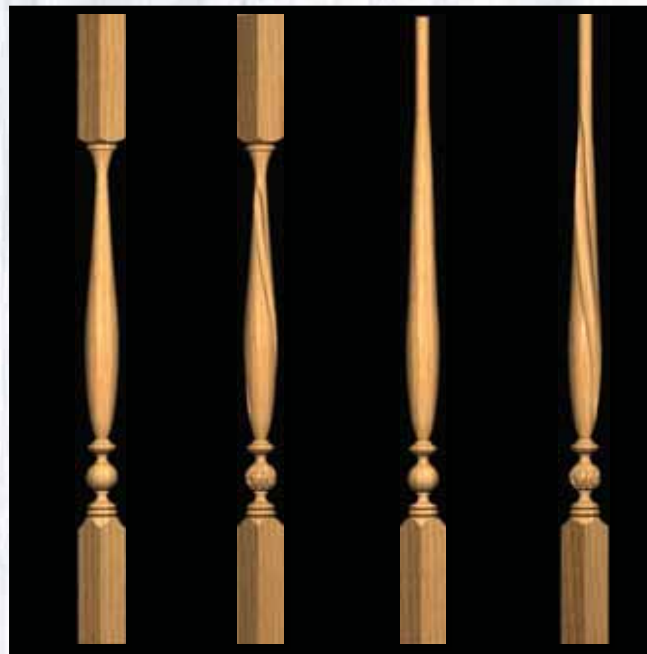

Options:
Pineapple Ball

Decorative Ball



Ordering Example:
ME05-1TW-PB

ON • THE • RISE	ME05	ME05-1TW-PB	ME15	ME15-1TW-PB
Thickness (Square)	1 3/4"	1 3/4"	1 3/4"	1 3/4"

Handrails



B5100



B5208



B5226



B5310



B5400



B5700



B5900



ON THE RISE™

Available Lengths:
34", 38", and 42"

The bottom square becomes longer as the baluster height increases. The turned area is parallel to the rake (rise) of the stair. Balusters are trimmed from the bottom (loose dowel pin).

Rounded



Round
Top and
Bottom
Blocks
Available

For rail
specifications
see page 52.

Bottom
Rails

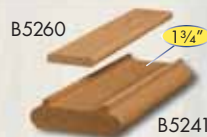

Over the Post

NEWELS
Pin
B
C
W

ME74 ME75 ME78 ME60C

Newels	Height	B Turning Length	C Bottom Block	W Width
STARTING				
ME74	50"	27"	22"	3 1/2"
LANDING				
ME75	58"	27"	30"	3 1/2"
ANGLE (WINDER)				
ME78	73"	27"	45"	3 1/2"
VOLUTE/TURNOUT (Adjustable)				
ME60C	50"	27"	ADJ	3 1/2"

VOLUTES/TURNOUTS
Pin
B
C
Bottom Pin
W

ME74
ME75
ME78

Twist 1

ME74-1TW-PB
ME75-1TW-PB
ME78-1TW-PB

Post to Post

Finial
A
B
C
W

ME80 ME82 ME85 ME86 ME93 ME95 ME98

Ball Top Posts	Height	A Top Block	B Turning Length	C Bottom Block	W Width
STARTING					
ME80	48"	5"	24"	14 5/8"	3 1/2"
ME82	58"	5"	24"	24 5/8"	3 1/2"
ME93	62"	5"	24"	28 5/8"	3 1/2"
ME95	73"	5"	24"	39 5/8"	3 1/2"
ME98	78"	5"	24"	44 5/8"	3 1/2"
2ND FLOOR LANDING					
ME85	58"	11"	20 1/2"	22 1/8"	3 1/2"
INTERMEDIATE LANDING					
ME86	73"	14 1/2"	17"	37 1/8"	3 1/2"

Finial
A
B
C
W

ME80
ME82
ME85
ME86

Twist 1

ME80-1TW-PB
ME82-1TW-PB
ME85-1TW-PB
ME86-1TW-PB

The new premium Limited Reserve Collection was created to suit your signature style with a combination of classic and modern designs. The Woodbury Series features non-tapered turnings with an exciting variety of milling options.

2 Barley Open Twist 2 Ribbon 3 Ribbon 2 Barley Open Twist 2 Ribbon 3 Ribbon

Handrails



B5100



B5208



B5226



B5310



B5400



B5700



B5900

BALUSTERS

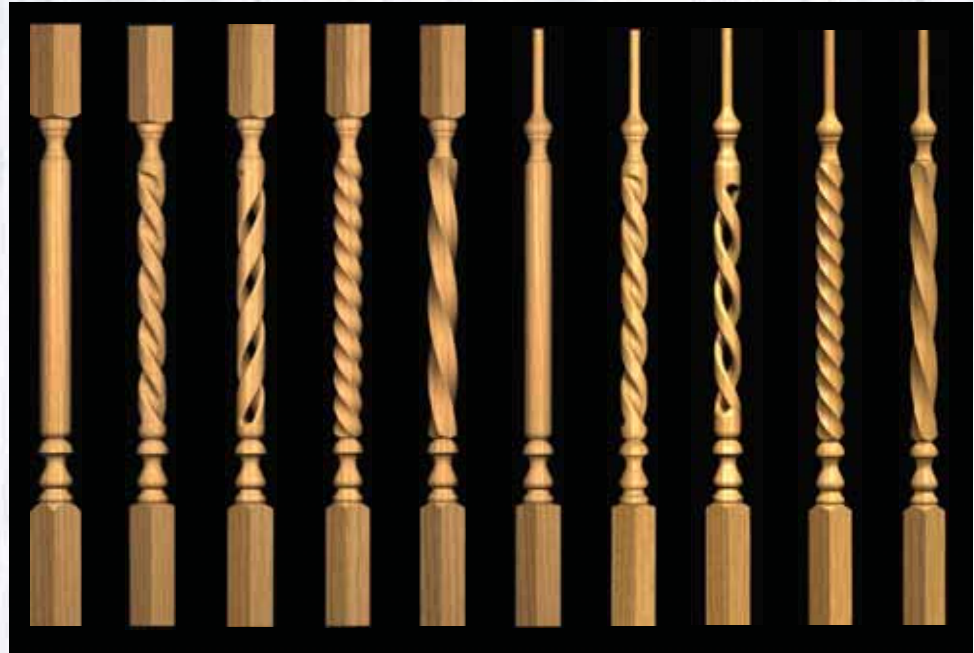

ON-THE-RISE	WB05	WB05-2BAR	WB05-OPEN-T	WB05-2RIB	WB05-3RIB	WB15	WB15-2BAR	WB15-OPEN-T	WB15-2RIB	WB15-3RIB
Thickness (Square)	1 3/4"	1 3/4"	2"	1 3/4"	1 3/4"	1 3/4"	1 3/4"	2"	1 3/4"	1 3/4"

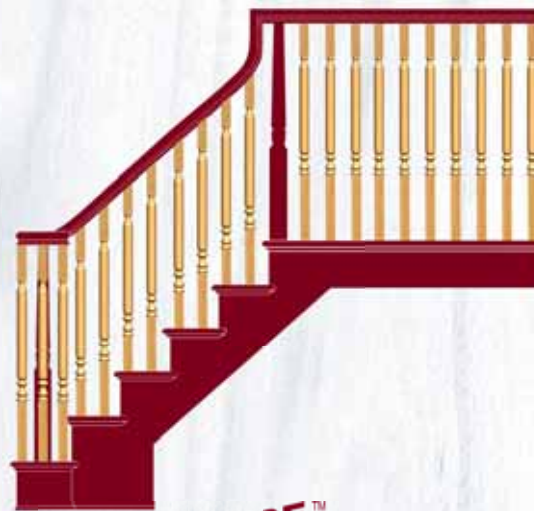

ON THE RISE™

Available Lengths: 34", 38", and 42"

The bottom square becomes longer as the baluster height increases. The turned area is parallel to the rake (rise) of the stair. Balusters are trimmed from the bottom (loose dowel pin).



For rail specifications see page 52.

Bottom Rails

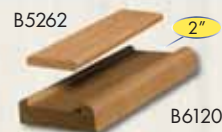
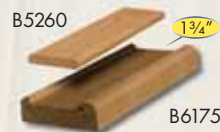
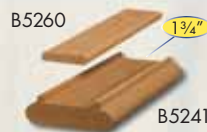

Over the Post

NEWELS

Newels	Height	B Turning Length	C Bottom Block	W Width
STARTING				
WB74	50"	27"	22"	3 1/2"
LANDING				
WB75	58"	27"	30"	3 1/2"
ANGLE (WINDER)				
WB78	73"	27"	45"	3 1/2"
VOLUTE/TURNOUT (Adjustable)				
WB60C	50"	27"	ADJ	3 1/2"

VOLUTES/TURNOUTS

2 Barley
Open Twist
2 Ribbon
3 Ribbon

-2BAR
-OPEN-T
-2RIB
-3RIB

Available in 3 newel lengths: WB74, WB75, WB78 (plain shown in measurement chart)

Post to Post

Ball Top Posts	Height	A Top Block	B Turning Length	C Bottom Block	W Width
STARTING					
WB80	48"	5"	24"	15 1/2"	3 1/2"
WB82	58"	5"	24"	25 1/2"	3 1/2"
WB93	62"	5"	24"	29 1/2"	3 1/2"
WB95	73"	5"	24"	40 1/2"	3 1/2"
WB98	78"	5"	24"	45 1/2"	3 1/2"
2ND FLOOR LANDING					
WB85	58"	11"	19 1/2"	24"	3 1/2"
INTERMEDIATE LANDING					
WB86	73"	14 1/2"	16"	39"	3 1/2"

2 Barley
Open Twist
2 Ribbon
3 Ribbon

-2BAR
-OPEN-T
-2RIB
-3RIB

Available in 5 post lengths: WB80, WB82, WB93, WB95, WB98 (plain shown in measurement chart)

The Lomond Series features hourglass shaped turnings with center details.

Over the Post



NEWELS

**VOLUTES/
TURNOUTS**

Newels	Height	B Turning Length	C Bottom Block	W Width
STARTING				
LM74	50"	27"	22"	3 1/2"
LANDING				
LM75	58"	27"	30"	3 1/2"
ANGLE (WINDER)				
LM78	73"	27"	45"	3 1/2"
VOLUTE/TURNOUT (Adjustable)				
LM60C	50"	27"	ADJ	3 1/2"

ON THE RISE™
BALUSTERS

LM05

Thickness	1 3/4"
Available Lengths	34", 38", and 42"

Post to Post

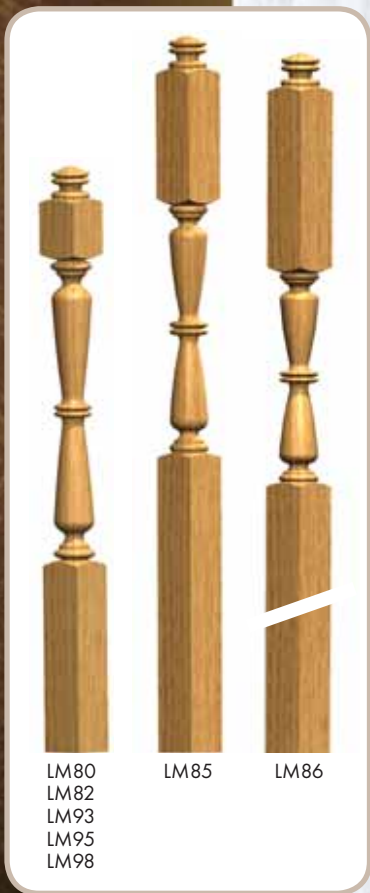

Finial

Ball Top Posts	Height	A Top Block	B Turning Length	C Bottom Block	W Width
STARTING					
LM80	48"	5"	24"	16"	3 1/2"
LM82	58"	5"	24"	26"	3 1/2"
LM93	62"	5"	24"	30"	3 1/2"
LM95	73"	5"	24"	41"	3 1/2"
LM98	78"	5"	24"	46"	3 1/2"
2ND FLOOR LANDING					
LM85	58"	11"	19 1/2"	24 1/2"	3 1/2"
INTERMEDIATE LANDING					
LM86	73"	14 1/2"	16"	39 1/2"	3 1/2"



ON THE RISE™
BALUSTERS

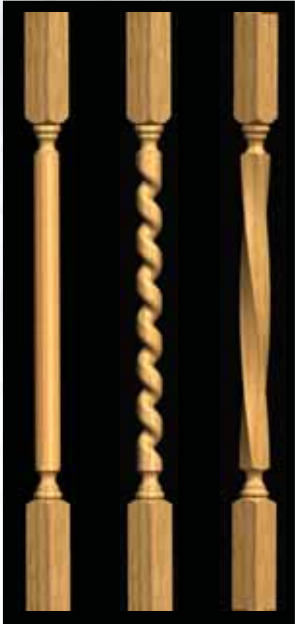

SS05 SS05-1BAR SS05-1RIB

Thickness	1 3/4"
Available Lengths	34", 38", and 42"

The Sussex Series features clean and modern non-tapered turnings.

Over the Post

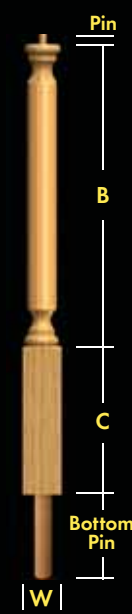
Newels	Height	B Turning Length	C Bottom Block	W Width
STARTING				
SS74	50"	27"	22"	3 1/2"
LANDING				
SS75	58"	27"	30"	3 1/2"
ANGLE (WINDER)				
SS78	73"	27"	45"	3 1/2"
VOLUTE/TURNOUT (Adjustable)				
SS60C	50"	27"	ADJ	3 1/2"

1 Barley 1 Ribbon



-1 BAR -1 RIB



Available in 3 newel lengths:
SS74, SS75, SS78
(plain shown in measurement chart)

Post to Post

Rounded



Round Top and Bottom Blocks Available

Ball Top Posts	Height	A Top Block	B Turning Length	C Bottom Block	W Width
STARTING					
SS80	48"	5"	24"	15 1/2"	3 1/2"
SS82	58"	5"	24"	25 1/2"	3 1/2"
SS93	62"	5"	24"	29 1/2"	3 1/2"
SS95	73"	5"	24"	40 1/2"	3 1/2"
SS98	78"	5"	24"	45 1/2"	3 1/2"
2ND FLOOR LANDING					
SS85	58"	11"	19 1/2"	24"	3 1/2"
INTERMEDIATE LANDING					
SS86	73"	14 1/2"	16"	39"	3 1/2"

1 Barley 1 Ribbon



-1 BAR -1 RIB

Available in 5 post lengths:
SS80, SS82, SS93, SS95, SS98
(plain shown in measurement chart)

MOD 11 Hand Carved Decorative Scroll

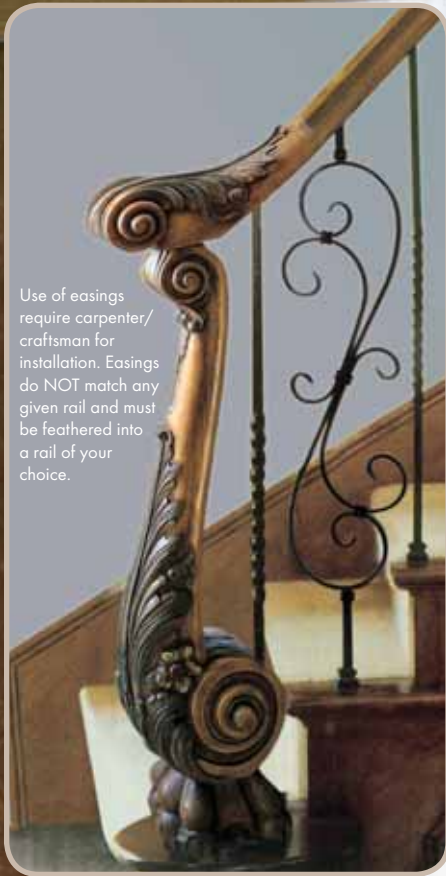

Use of easings require carpenter/craftsman for installation. Easings do NOT match any given rail and must be feathered into a rail of your choice.

NEWELS

29 1/2"

43 5/16"

4 7/16" Sq

3 9/16" Sq

7 1/16" x 7 7/8" N24A

N11A N11B

BALUSTER

43 5/16"

2 1/16" Sq

B11

Straight Easing
1 1 7/8" x 5 7/8" x 4 3/4"

Right Hand Easing
1 1 7/8" x 5 7/8" x 4 3/4"

Left Hand Easing
1 1 7/8" x 5 7/8" x 4 3/4"

Claw Base
6 5/16" x 6 5/16" x 6 5/16"

SE11

TR11

TL11

N24B



MOD 14 Hand Carved Double Pen Nib

NEWEL

46 1/16"

4 15/16"

6 5/16"

N14

BALUSTER

41 5/16"

1 3/8"

5 7/8"

B14



Post Tops are pictured on page 36

Euro Beech
Models 11, 14, 15, 40 and 45 are made of fine European Beech, a specie which offers much flexibility for staining options.

MOD 15 Hand Carved Decorative Twine

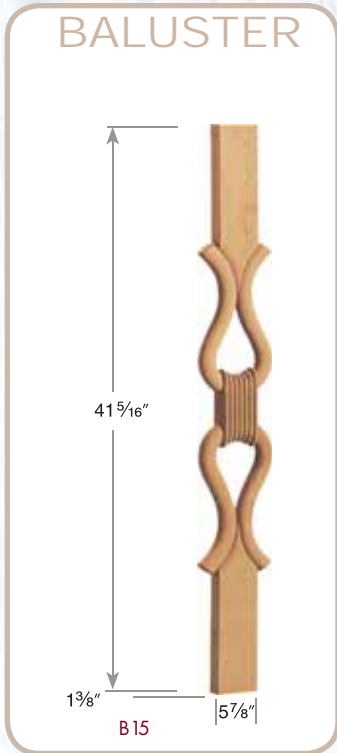

MOD 40 Hand Carved Enhanced Decorative Scroll

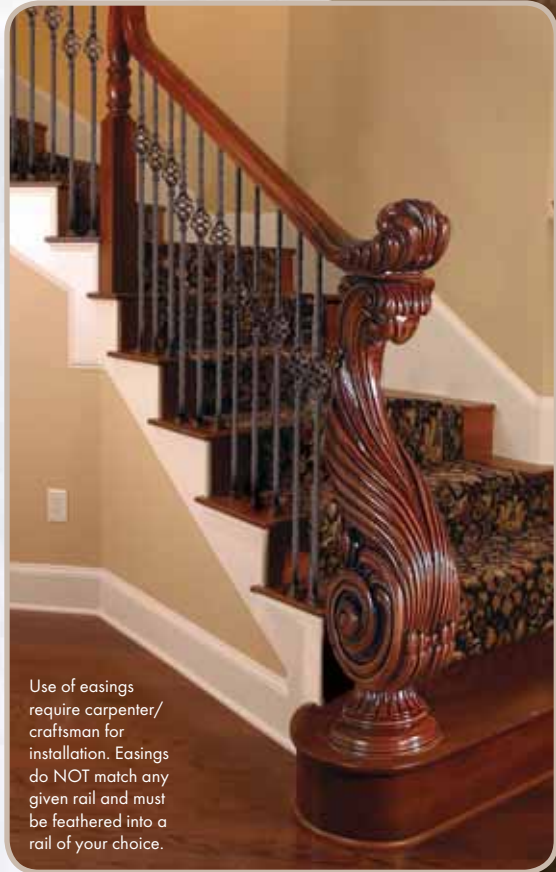

MOD 45 Hand Carved Enhanced Swan



MOD 99 Hand Carved Decorative Posts and Balusters

Available in Hard Maple, Oak and Cherry.

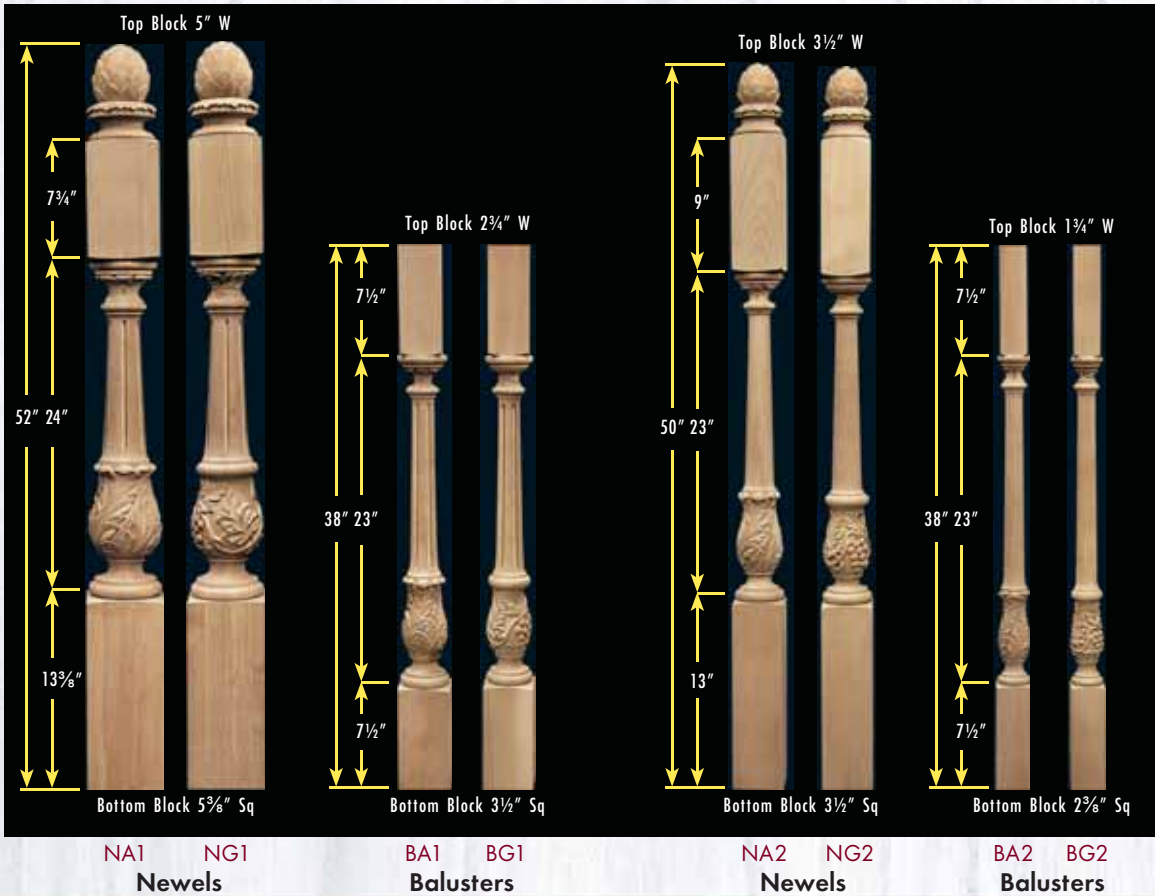

Hand Carved Newel Caps



PT680A

4 7/16" x 9 7/16"



PT680B

3 9/16" x 7 1/16"



PT690A

4 7/16" x 9 7/16"



PT690B

3 9/16" x 7 1/16"



PT700A

4 7/16" x 8 1/16"



PT700B

3 9/16" x 6 1/2"



PT705A

4 7/16" x 8 1/16"



PT705B

3 9/16" x 6 1/2"

IRON BALUSTERS

Iron Baluster Measurement Tips

• StairTrends iron balusters are 44" in length with details centered 18" from the top unless noted.

- Cut as needed from the bottom.
- Most square balusters have a domed top to the baluster for easy installation into the handrail.
- Standard balusters are 1/2" x 1/2".
- Hammered series balusters are 9/16" x 9/16".
- Mega Square series, page 50, are 3/4" x 3/4" and Venetian Round, page 49 is 5/8" diameter.

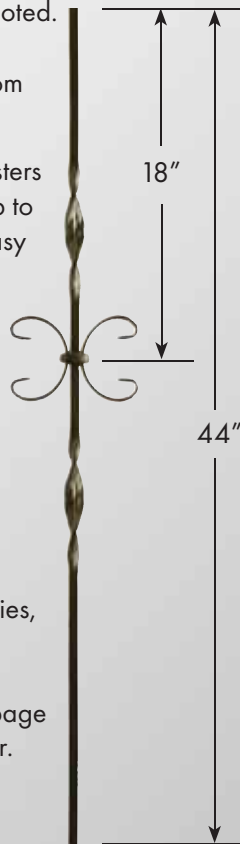

HEIGHT EXCEPTIONS

Balusters Series	Height	Page
Belly Posts	40"	44
Collarless	41"	44
M40840	40"	40
M55541	41"	39
REN PANEL	42"	39



1/2" SQUARE

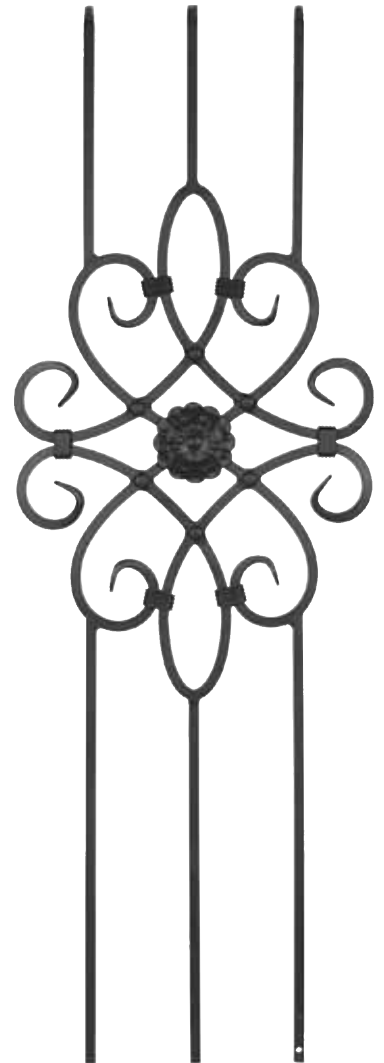

M39944

14 7/8" W at scroll, 9" W at base x 44" H

Finishes



To specify your type of finish, add the letter code after each item number.

Decorative Series

More Decorative Panel designs at StairTrends.com

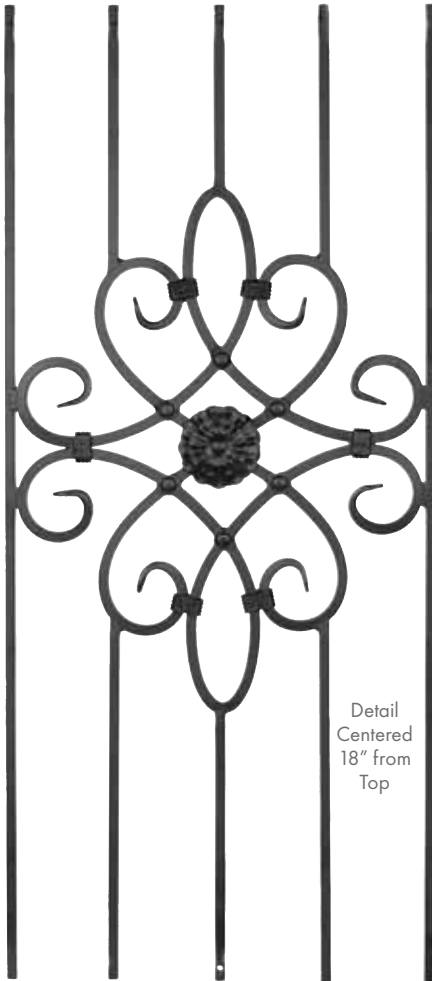

M55541
17 3/4" W x 41" H

Detail
Centered
18" from
Top

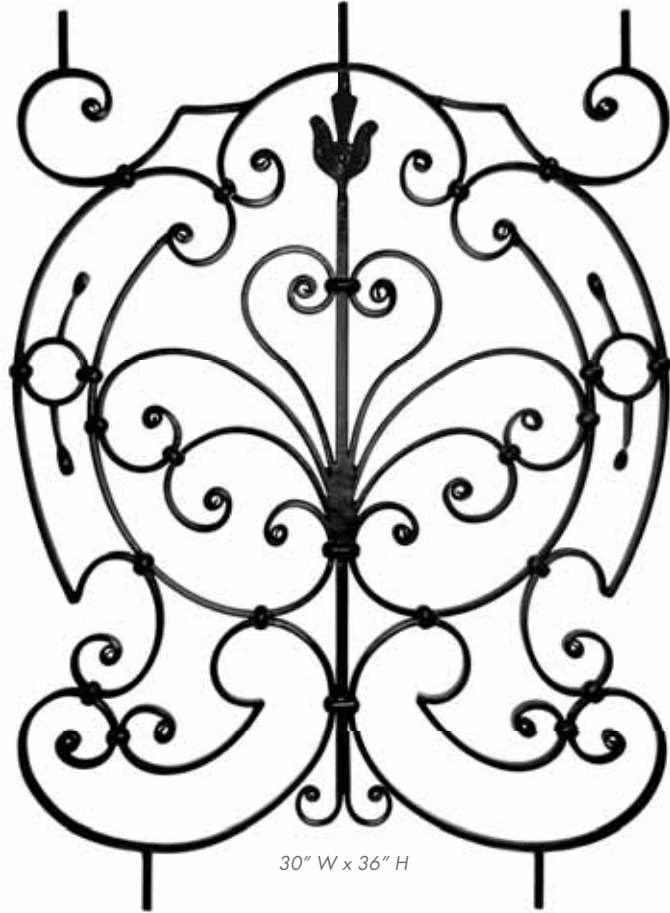

30" W x 36" H

RENPANEL
N/A in NV

1/2" Baluster Thickness

1/2" SQUARE

Handrail Bracket Matching Accessories

ABZ Antique Bronze
(Textured)



3011-ABZ

PC Grey-Black
(Textured)



3012-PC

B Flat Black
(Lightly Textured)



3013-B

SAT
Smooth Satin Black



3016-SAT

NV Nickel Verde
(Hand Rubbed)



3017-NV

ORC
Oil Rubbed Copper



3018-ORC

ORB
Oil Rubbed Bronze



3019-ORB

IRON BALUSTERS

Designer Balusters & Panels

Designer Series is available in Flat Black Only

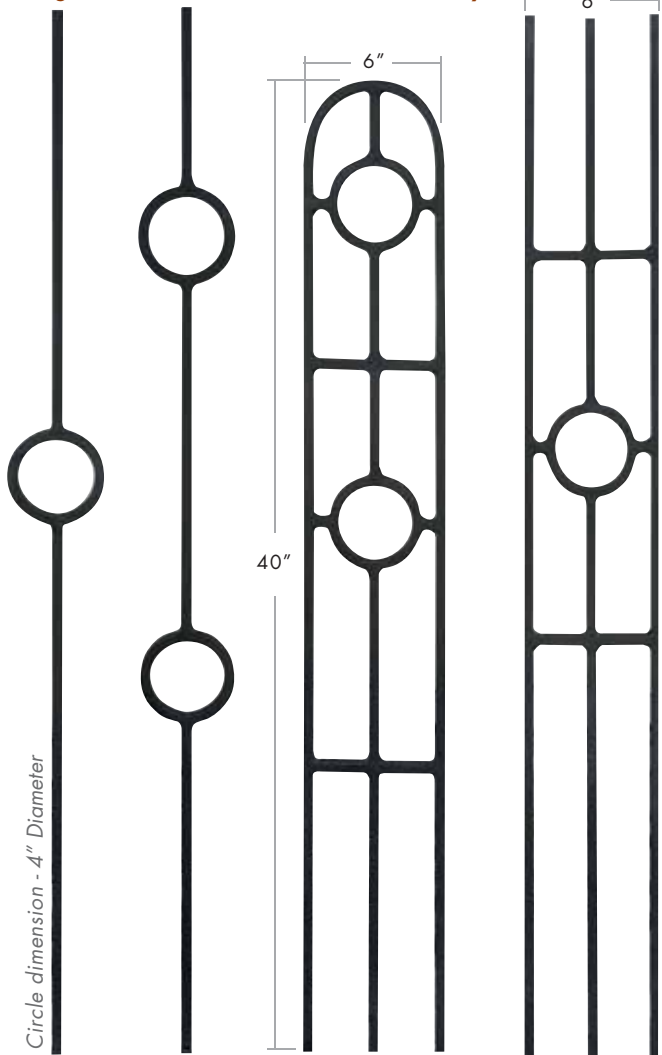

M40144

B only

M40244

B only

M40840

B only

M41144

B only



ME03



ME07



ME07PB



ME08



US05

4" Diameter
Designer
Medallion

Inserts include a front and back that screw together.

ME07PB is a painted gold finish. All other designs are Flat Black.

Circle dimension - 4" Diameter

40"

6"

6"

1/2" SQUARE

Knuckle Square



1KNUC44

Tubular*

2KNUC44

Tubular*

2KNUC1BASK44

Solid

*NV finish is Solid

1/2" Baluster Thickness - The top of these balusters are square, not domed.

1/2" Baluster Thickness

Available Finishes	B	SAT	PC	ABZ	NV	ORC	ORB
	Flat Black (lightly textured)	Satin Black (smooth finish)	Grey Black	Antique Bronze	Nickel Verde (hand rubbed)	Oil Rubbed Copper (hand rubbed)	Oil Rubbed Bronze (hand rubbed)

Knuckles For use with PLA44 Plain Baluster



AK01
Adjustable
Knuckle
1 1/2" x 2"



AK03
Urn Adjustable
Knuckle
1 3/8" x 1 3/8"



AK02
Fluted Barrel
Adjustable
Knuckle
1 1/2" x 1 1/2"



AK05
Tall Barrel
Adjustable
Knuckle
1 3/8" x 2 1/4"



AK04
Fluted Deco
Adjustable
Knuckle
7/8" x 6"



Twist & Basket Square

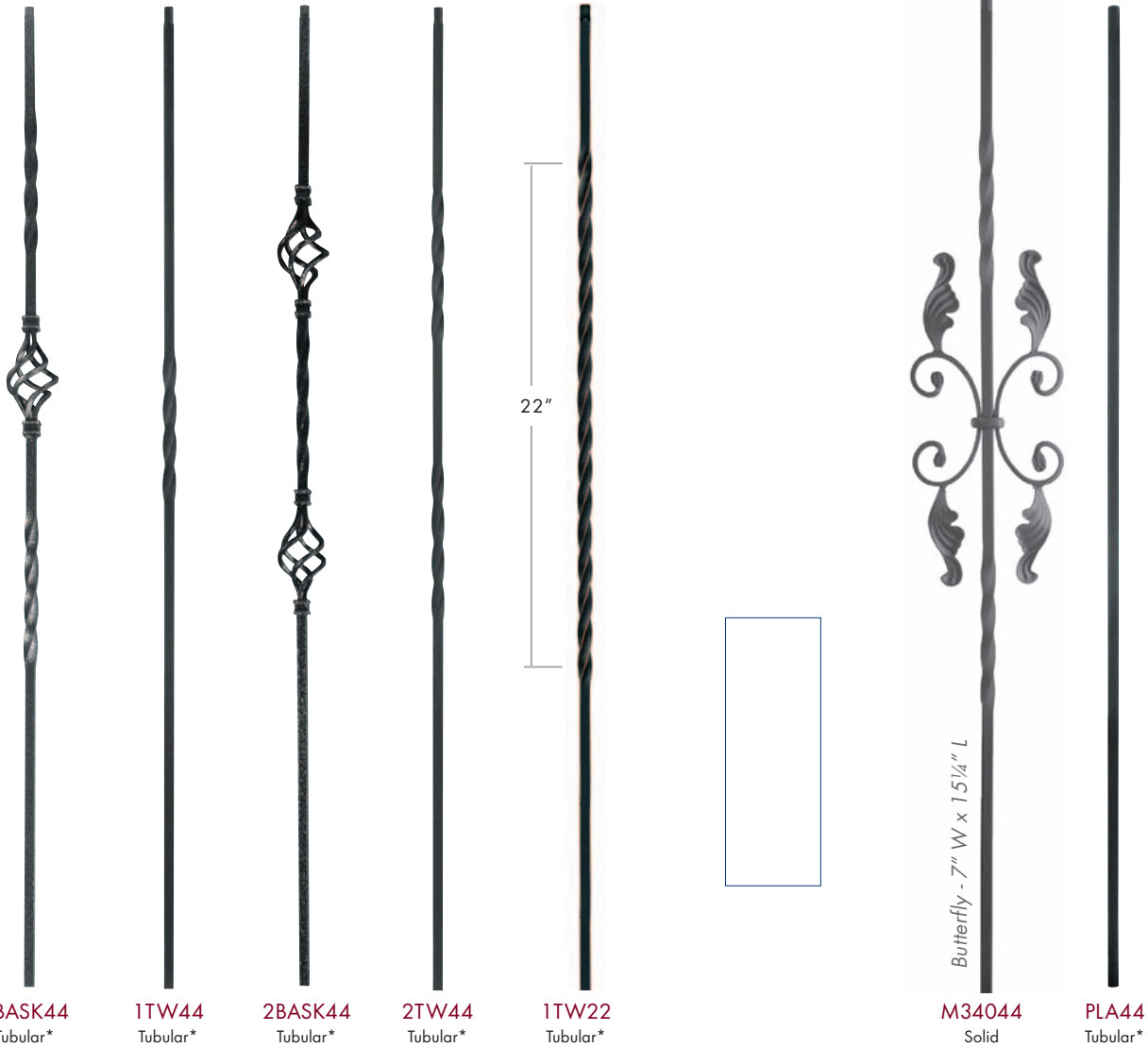

1BASK44
Tubular*

1TW44
Tubular*

2BASK44
Tubular*

2TW44
Tubular*

1TW22
Tubular*

M34044
Solid

PLA44
Tubular*

B, SAT, ABZ, ORC

*NV finish is Solid

1/2" Baluster Thickness - DOMED tops and SQUARE bottoms

Available Finishes	B	SAT	PC	ABZ	NV	ORC	ORB
	Flat Black (lightly textured)	Satin Black (smooth finish)	Grey Black	Antique Bronze	Nickel Verde (hand rubbed)	Oil Rubbed Copper (hand rubbed)	Oil Rubbed Bronze (hand rubbed)

1/2" SQUARE

Iron Shoes for 1/2" Square Installations

IRON SHOES	Page
Universal Square	44
9/16" Square	45
All Round	47,48
3/4" Mega Square	49



Shoe Model Number	FSH01	M06	M020	M022	SCR04	PSH02
Available Finishes	All	All	B, SAT, PC, ABZ	B, PC	All	All
Shoe Base Dimensions	1 1/2" Square	1 3/8" Square	1 7/8" Diameter	2" Square	2 1/2" X 1 1/2"	1 1/4" Square

Finishes: B (Flat Black), SAT (Satin Black), PC (Grey Black), ABZ (Antique Bronze), NV (Nickel Verde), ORC (Oil Rubbed Copper), ORB (Oil Rubbed Bronze). FSH01, M06 & PSH02 are shipped in aluminum for easy installation (Finish NV excepted). All other shoes are iron.

Scroll & Unique Square

1/2" SQUARE



Scroll 7" W x 24" L

M301



Scroll 5 1/2" W x 16" L

M501



Scroll 5 1/2" W x 22 1/2" L

M601



Scroll 7" W x 16" L

M321

N/A in NV



Scroll 5" W x 24" L

M331

N/A in PC



Scroll 5" W x 26" L

MDS

N/A in NV



Scroll 5" W x 12" L

MSS



Knot 3 1/2" W x 4 1/2" L

KNOT44 WAVE44

B & ABZ only



Wave 1 1/4" W x 30" L

1/2" Baluster Thickness

Available Finishes	B	SAT	PC	ABZ	NV	ORC	ORB
	Flat Black (lightly textured)	Satin Black (smooth finish)	Grey Black	Antique Bronze	Nickel Verde (hand rubbed)	Oil Rubbed Copper (hand rubbed)	Oil Rubbed Bronze (hand rubbed)



Ribbon Square

1/2" SQUARE

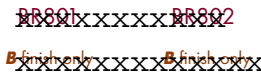
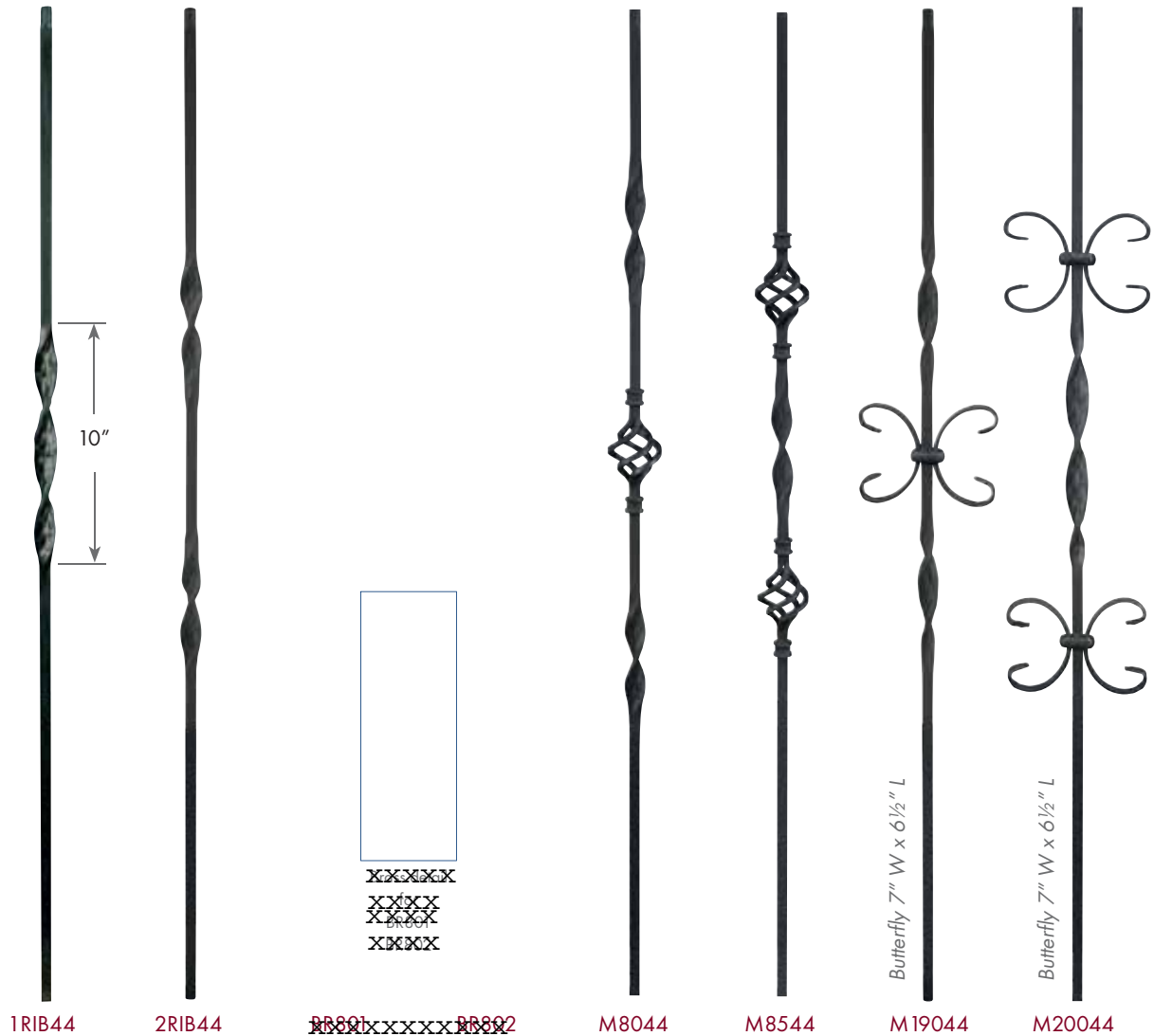

1/2" Baluster Thickness

Available Finishes	B	SAT	PC	ABZ	NV	ORC	ORB
	Flat Black (lightly textured)	Satin Black (smooth finish)	Grey Black	Antique Bronze	Nickel Verde (hand rubbed)	Oil Rubbed Copper (hand rubbed)	Oil Rubbed Bronze (hand rubbed)

Installation Products



A501K
Fast Setting Epoxy Kit
includes 5 oz. A-7 epoxy,
A-24 nozzle & piston
for use with standard
caulking gun
(gun not included).

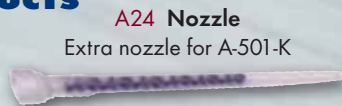

A24 Nozzle
Extra nozzle for A-501-K



F120 Mixing Nozzle for F300



F101
Injector Tool for
F300 adhesive.

F300 Slow Cure Epoxy
20-30 minute work time. 11 oz. cartridge,
will install 60-80 balusters, both ends.
Mixing nozzle not included - order F120.

IRON BALUSTERS

1/2" SQUARE

Twist & Basket Square Collarless - 41"

Collarless Series is available in Flat Black Only

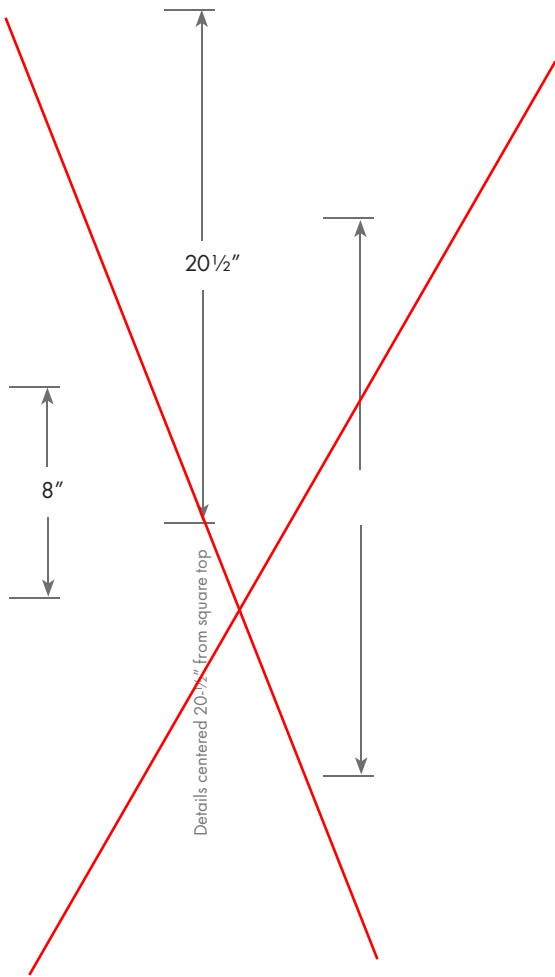

- M-1-41
B only
- M-2-41
B only
- M-3-41
B only
- M-4-41
B only
- M-5-41
B only

1/2" Baluster Thickness - SQUARE tops and bottoms

Belly Square Balusters - 40"

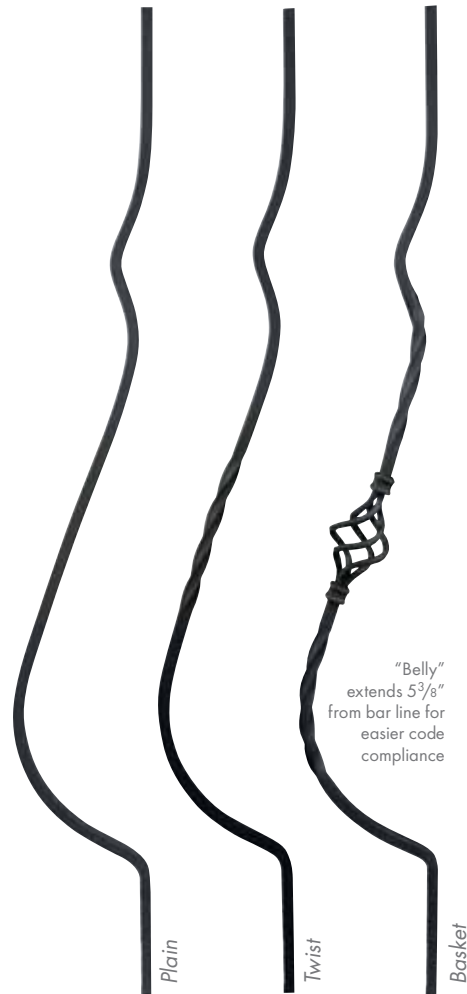

- PLA40-BLY
N/A in **NV**
- 1TW40-BLY
N/A in **NV**
- 1BASK-BLY
N/A in **NV**

1/2" Baluster Thickness - SQUARE tops and bottoms

Available Finishes	B	SAT	PC	ABZ	NV	ORC	ORB
	Flat Black (lightly textured)	Satin Black (smooth finish)	Grey Black	Antique Bronze	Nickel Verde (hand rubbed)	Oil Rubbed Copper (hand rubbed)	Oil Rubbed Bronze (hand rubbed)

Universal Iron Shoes for 1/2" or 9/16" Square Installations

IRON SHOES	Page
1/2" Square	41
9/16" Square	45
All Round	48,49
3/4" Mega Square	50



Shoe Model Number	RD201	SQ301	RM020	RM201	RM301
Available Finishes	All	All	B, SAT, PC, ABZ	All	All
Shoe Base Dimensions	1 7/8" Diameter	1 5/8" Square	2" Diameter	2" Diameter	2" Square

Finishes: B (Flat Black), SAT (Satin Black), PC (Grey Black), ABZ (Antique Bronze), NV (Nickel Verde), ORC (Oil Rubbed Copper), ORB (Oil Rubbed Bronze)

Gothic Hammered

Brass
XXXXXX
detail for
XXXXXX



Gothic Hammered Bar close-up



M14344

M14044

M15044

M16044

~~BB161~~

B finish only

9/16" Baluster Thickness

9/16" SQUARE

Available Finishes	B	SAT	PC	ABZ	NV	ORC	ORB
	Flat Black (lightly textured)	Satin Black (smooth finish)	Grey Black	Antique Bronze	Nickel Verde (hand rubbed)	Oil Rubbed Copper (hand rubbed)	Oil Rubbed Bronze (hand rubbed)

Iron Shoes for 9/16" Square Installations

IRON SHOES	Page
1/2" Square	41
Universal Square	44
All Round	48,49
3/4" Mega Square	50

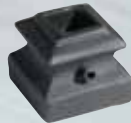

Shoe Model Number	H03	H06	H020	H04	H05P
Available Finishes	All	All	B (Flat Black)	All	All
Shoe Base Dimensions	1 1/2" Square	1 3/8" Square	1 7/8" Diameter	2 1/2" X 1 1/2"	1 1/4" Square

Finishes: B (Flat Black), SAT (Satin Black), PC (Grey Black), ABZ (Antique Bronze), NV (Nickel Verde), ORC (Oil Rubbed Copper), ORB (Oil Rubbed Bronze). H05P & H06 are shipped in aluminum for easy installation (Finish NV excepted). All other shoes are iron.

IRON BALUSTERS

9/16" SQUARE

Santa Fe Forged Hammered



M9044 M10044 M11044 M12044 M13044

Butterfly 7" W x 6 1/2" L

9/16" Baluster Thickness

Ball Forged Hammered



M305 M308 M310

Scroll 5" W x 14.6" L

N/A in NV

9/16" Baluster Thickness

Old English Forged Hammered



M9044 M330 M13144 M13244

Scroll - 5" W x 14.6" L

N/A in NV

9/16" Baluster Thickness

Available Finishes	B	SAT	PC	ABZ	NV	ORC	ORB
	Flat Black (lightly textured)	Satin Black (smooth finish)	Grey Black	Antique Bronze	Nickel Verde (hand rubbed)	Oil Rubbed Copper (hand rubbed)	Oil Rubbed Bronze (hand rubbed)

Iron Shoes

see the following pages:

IRON SHOES	Page
1/2" Square	41
Universal Square	44
9/16" Square	45
All Round	48,49
3/4" Mega Square	50



Forged Hammered Bar close-up



Detail of M13144 and M13244

Scroll Forged Hammered



Scroll 5 1/4" W x 13 1/2" L

Scroll 5 1/4" W x 15 1/4" L

Scroll 5" W x 26" L

M13544
N/A in NV

M30344
N/A in NV

MHDS
N/A in NV

9/16" Baluster Thickness

Tudor Forged Hammered

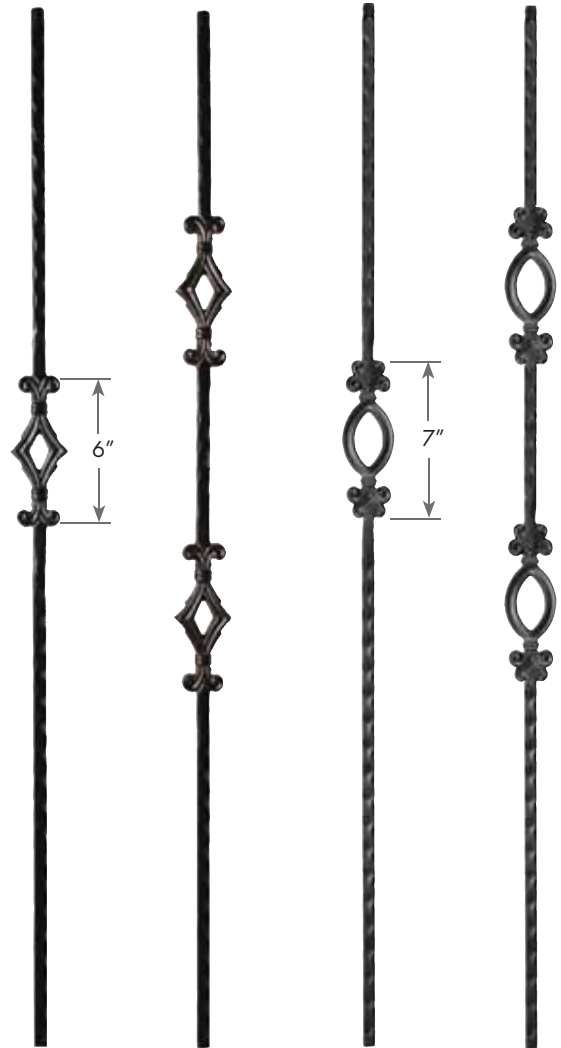

M13344
N/A in NV

M13444
N/A in NV

M13644
N/A in NV

M13744
N/A in NV

9/16" Baluster Thickness

Available Finishes	B	SAT	PC	ABZ	NV	ORC	ORB
	Flat Black (lightly textured)	Satin Black (smooth finish)	Grey Black	Antique Bronze	Nickel Verde (hand rubbed)	Oil Rubbed Copper (hand rubbed)	Oil Rubbed Bronze (hand rubbed)

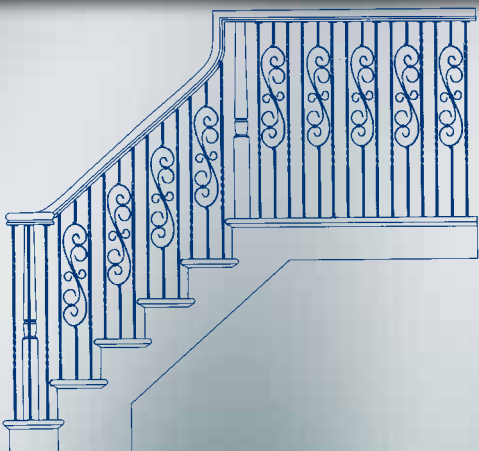

Detail of M13344 decorative "diamond" window



Detail of M13644 decorative "oval" window

9/16" SQUARE

IRON BALUSTERS

1/2" ROUND • 9/16" ROUND

Roman Round



Round balusters have round tops and bottoms.

- R60044
N/A in NV
- R60144
N/A in NV
- R60244
N/A in NV
- R61144
N/A in NV
- R61244
N/A in NV

1/2" Baluster Thickness (Textured)

Arrow Round

Arrow Round Series is available in Flat Black Only



- R20044
B only
- R21044
B only
- R22044
B only
- R22544
B only

9/16" Baluster Thickness

Available Finishes	B	SAT	PC	ABZ	NV	ORC	ORB
	Flat Black (lightly textured)	Satin Black (smooth finish)	Grey Black	Antique Bronze	Nickel Verde (hand rubbed)	Oil Rubbed Copper (hand rubbed)	Oil Rubbed Bronze (hand rubbed)



Iron Shoes for 1/2" & 9/16" Round Installations



Flat Square Shoe Pitched Shoe

For 1/2" round balusters	RO8F	RO9P
For 9/16" round balusters	RO7F	RO6P
Shoe Base Dimensions	1 1/2" Square	1 1/4" Square

- Finishes:
- 1/2" shoe: All finishes - except NV
 - 9/16" shoe: B only

Gothic Round

Available in Flat Black Only



R54344 R54044 R55044
B only *B* only *B* only

9/16" Baluster Thickness

Venetian



Fluted Fluted

7" 22"

R-65044 R-65244 R-65644 R-65844
 N/A in *NV* N/A in *NV* N/A in *NV* N/A in *NV*

5/8" Round

Matching Iron Newels



NEWL-140GOTHIC NEWL-BASK48 NEWL-RIB48 NEWL-TW48

12"

1-3/16" Thick x 48" Long including 1" Pin Top

Available Finishes	<i>B</i>	<i>SAT</i>	<i>PC</i>	<i>ABZ</i>	<i>NV</i>	<i>ORC</i>	<i>ORB</i>
	Flat Black (lightly textured)	Satin Black (smooth finish)	Grey Black	Antique Bronze	Nickel Verde (hand rubbed)	Oil Rubbed Copper (hand rubbed)	Oil Rubbed Bronze (hand rubbed)

Venetian



Detail of Venetian decorative center

R65044

R10 Flat Round Shoe designed for Venetian style 2" diameter (pitched shoe not available)

Iron Newel Anchoring System



NC101 Newel Anchoring System w/Shoe

Available in 7 finishes:

- Satin Black (SB)
- Flat Black (B)
- Antique Bronze (ABZ)
- Grey-Black (PC)
- Oil-Rub Copper (ORC)
- Nickel Verde (NV)
- Oil Rub Bronze (ORB)

IRON BALUSTERS

3/4" MEGA Square Balusters

All MEGA balusters are rounded to 9/16" diameter on top for easy installation into handrail hole.

3/4" SQUARE

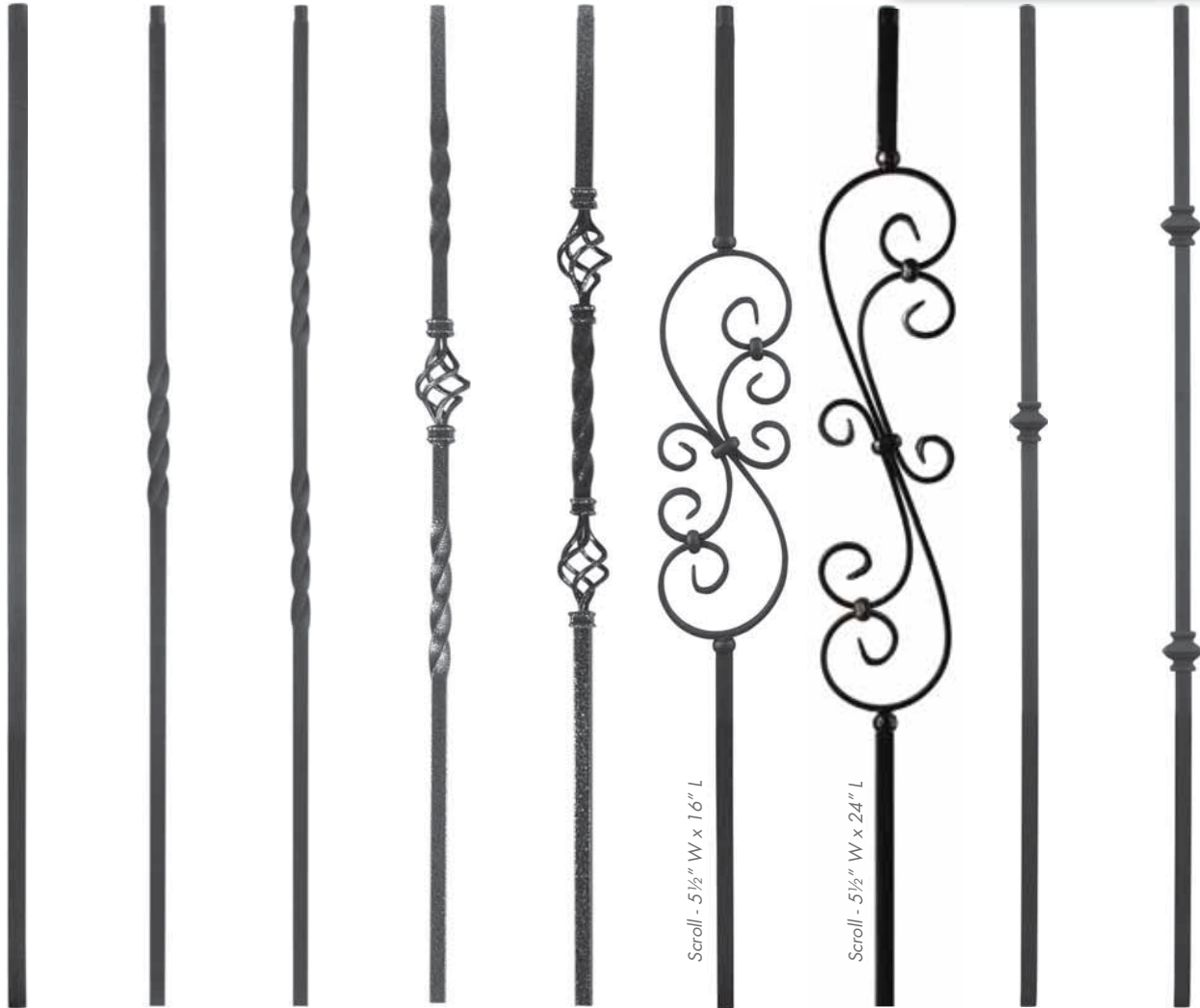

- MEGA-PLA
Tubular
N/A in **NV**
- MEGA-1TW
Tubular
N/A in **NV**
- MEGA-2TW
Tubular
N/A in **NV**
- MEGA-1BASK
Tubular
N/A in **NV**
- MEGA-2BASK
Tubular
N/A in **NV**
- MEGA-M501
Tubular
N/A in **NV**
- MEGA-M601
Tubular
N/A in **NV**
- MEGA-1KNUC
Tubular
N/A in **NV**
- MEGA-2KNUC
Tubular
N/A in **NV**

Scroll - 5 1/2" W x 16" L

Scroll - 5 1/2" W x 24" L

TUBULAR 3/4" Baluster Thickness

Available Finishes	B	SAT	PC	ABZ	NV	ORC	ORB
	Flat Black (lightly textured)	Satin Black (smooth finish)	Grey Black	Antique Bronze	Nickel Verde (hand rubbed)	Oil Rubbed Copper (hand rubbed)	Oil Rubbed Bronze (hand rubbed)

MEGA Iron Shoes for 3/4" Square Installations

IRON SHOES	Page
1/2" Square	41
Universal Square	44
9/16" Square	45
All Round	48,49



Shoe Model Number	MEGA-M08	MEGA-PSH08	MEGA-FSH08	MEGA-RD208	MEGA-SQ308
Available Finishes	All (except NV)	All (except NV)	All (except NV)	All (except NV)	All (except NV)
Shoe Base Dimensions	1 1/2" Square	1 1/2" Square	1 3/4" Square	2" Diameter	2" Square

Finishes: B (Flat Black), SAT (Satin Black), PC (Grey Black), ABZ (Antique Bronze), NV (Nickel Verde), ORC (Oil Rubbed Copper), ORB (Oil Rubbed Bronze)

HANDRAILS

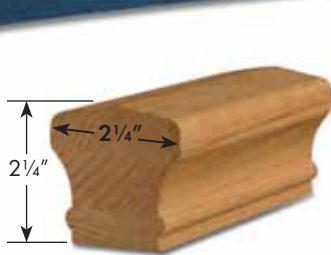

B5000
Available Plowed for 1 1/4"

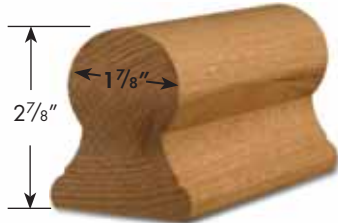

B5100
Available Plowed for 1 1/4" or 1 3/4"

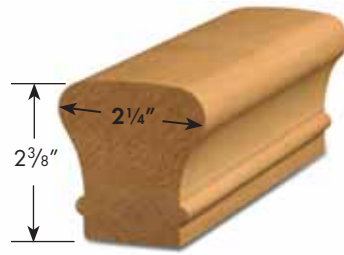

B5200
Available Plowed for 1 1/4"

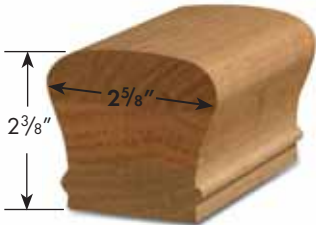

B5208
Available Plowed for 1 3/4"

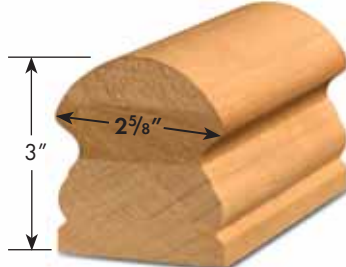

B5226
Available Plowed for 1 3/4" or 2"

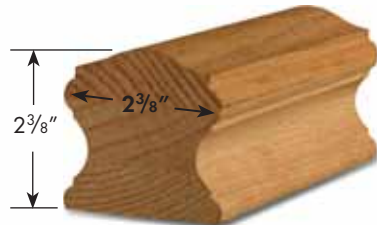

B5310
Available Plowed for 1 3/4"

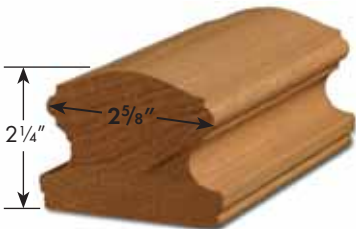

B5400
Available Plowed for 1 3/4" or 2"

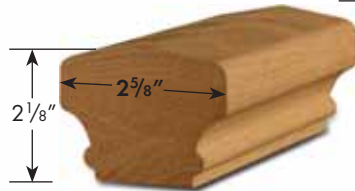

B5500
Available Plowed for 1 1/4"

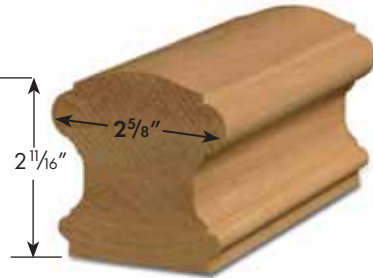

B5700
Available Plowed for 1 3/4"

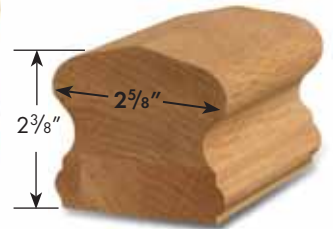

B5900
Available Plowed for 1 3/4"

For Bending Rail add "-B" to rail number. See our website for bending limitations. Pre-bent rail is available for tight radius applications.

CONTEMPORARY RAILS

Rails	Width	Height
B5235	1 5/8"	3 1/2"
B5255	1 5/8"	5 1/2"
B5275	1 5/8"	5 1/2"
B5285	1 1/4"	5 1/4"
B6100	2 3/4"	1 5/8"



B5235



B5255



B5275



B5285



B6100
Available Plowed for 1 1/4" or 1 3/4"

SHOE RAILS & FILLETS

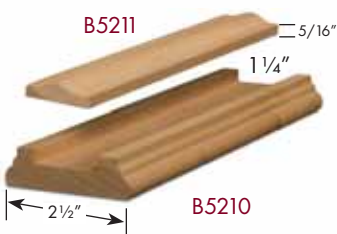

B5211

B5210

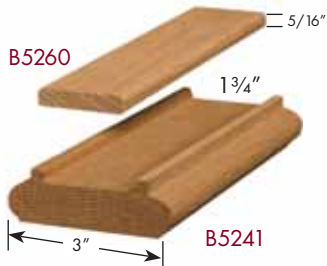

B5260

B5241

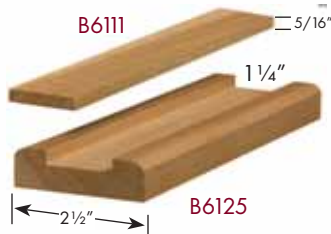

B6111

B6125

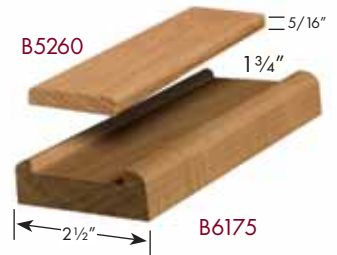

B5260

B6175



HANDRAIL	B5000	B5100	B5200	B5208	B5226	B5310	B5400	B5500	B5700	B5900
FITTING	B20--	B21--	B22--	B28--	B26--	B23--	B24--	B25--	B27--	B29--

Fittings may be ordered as plowed for square top balusters – add the suffix “-P” to the fitting number.

FITTING OPTIONS

All **Starting Fittings** are available with a 90° up easing attached. Specify the fitting with a -90 suffix.

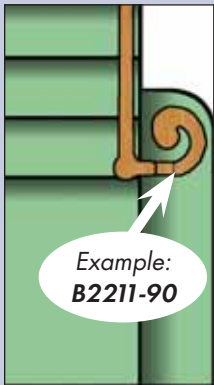

90° Fittings can be ordered as 135°.



Example:
B2201-135
B2209-135



Starting Easing with Cap	Starting Easing no Cap	Level Quarterturn	Up Easing	Over Easing	Over Easing Return End
B2#00	B2#00-B	B2#01	B2#02	B2#03	B2#03R



Up Easing 90°	Plain Cap	Opening Cap	Returned End	Tandem Cap	Coped End
B2#04	B2#06	B2#07	B2#35	B2#08	B2#38



Quarterturn with Cap	Volute Left Hand	Volute Right Hand	Climbing Volute Left Hand	Climbing Volute Right Hand
B2#09	B2#10	B2#11	only available as listed below	
			B2210-CL	B2211-CL
			B2810-CL	B2811-CL



Five Inch Offset Rail Right Hand	Five Inch Offset Rail Left Hand	Turnout Left Hand	Turnout Right Hand	Turnout Left Hand	Turnout Right Hand
B2#12	B2#13	Center to Center 2 5/8"		Center to Center 4 1/2"	
		B2#14	B2#15	B2#14A	B2#15A

GOOSENECKS

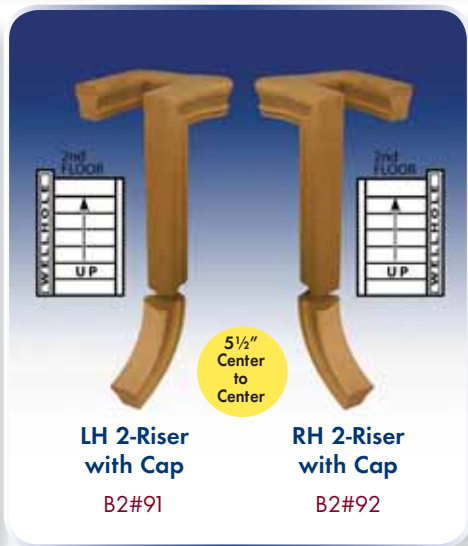
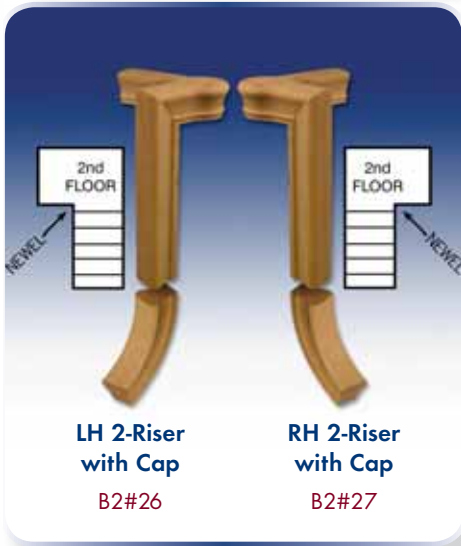
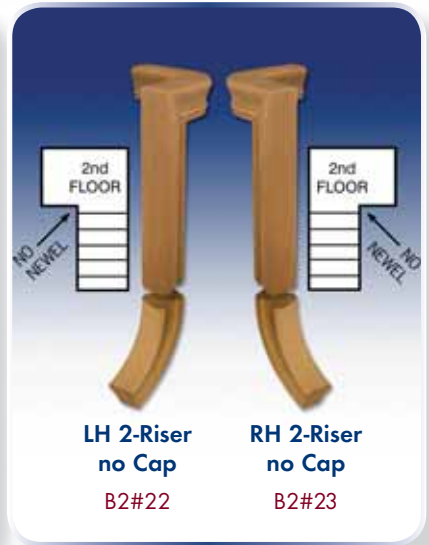
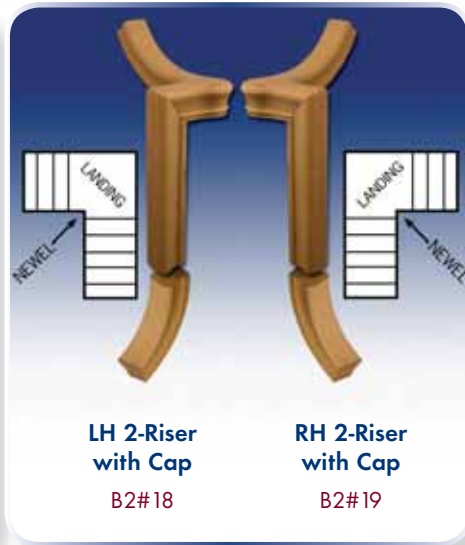
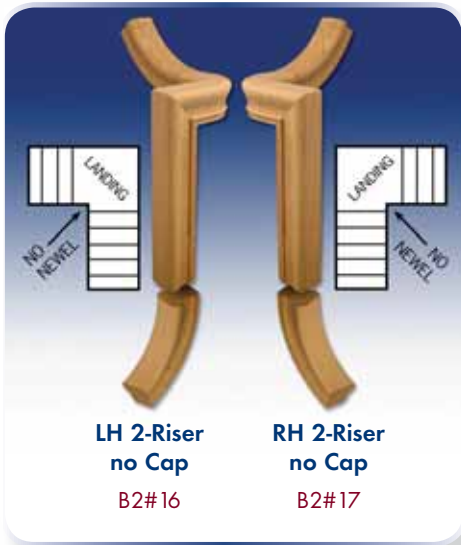

ROSETTES



B2205
4 1/2" Diameter
B2205B
6" Diameter



B2205A
4 7/16" x 6 1/2"
B2205C
6" x 7 3/8"



B2205SQ
4 5/8" Square



B2205REC
4 5/16" x 6"



WALL BRACKETS

Decorative wall brackets add elegance to open tread stairs.



B2236
11 1/2" x 8"



B2237
11 1/2" x 8 1/8"

NEWEL POST TOPS



PT9904
2 3/4" x 3 7/8"



PT9935
3 1/4" x 4 7/8"



PT9937
3 1/8" x 3 3/4"



PT9938
3 1/4" x 4 7/8"



PTLM
3" x 2 1/2"



PTSS
3" x 3"



PT9940
2 3/4" x 2 3/8"



PT9990COL
3 1/4" x 4 1/2"



PT9990-AC
3 1/4" x 4 1/4"



PTBY-RB
3 1/4" x 3 3/4"



PTME-PB
3 1/4" x 3 3/4"



PTWB
3" x 3"

NEWEL DROP



ND99

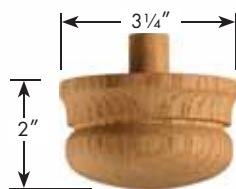

ND399

WALL RAILS



B5205

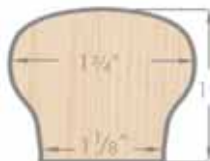

B5203

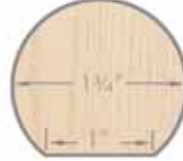

B5207



B5042

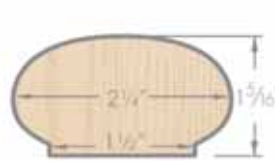

WALL RAIL FITTINGS

Quarterturn



Up Easing



Over Easing



Wall Rail Fittings Cross Reference Chart

RAIL	QUARTER-TURN	UP EASING	OVER EASING
B5203	B5213	B5214	B5215
B5207	B5217	B5218	B5219
B5042	B5021	B5022	B5023

STARTING STEPS

STARTING STEP includes Shoe and Cove. Risers are $\frac{3}{4}$ " x 7", total Rise $8\frac{1}{32}$ "; single Bullnose treads are reversible.

6 $\frac{1}{4}$ " Radius - use with Volutes and Turnouts



Single Bullnose

ITEM	Width of Cut-Out	Tread Depth	Bullnose
B6203	48"	11 1/2"	10 1/2"
B6205	60"	11 1/2"	10 1/2"
B6206	72"	11 1/2"	10 1/2"



Double Bullnose

ITEM	Width of Cut-Out	Tread Depth	Bullnose
B6256	42"	11 1/2"	21"
B6258	48"	11 1/2"	21"

Above starting steps accommodate Volutes and Turnouts in rail profiles B5200, B5208, B5000, B5310 and with Turnouts for B5500.

7 $\frac{3}{16}$ " Radius - use with Volutes, Turnouts and Climbing Volutes



Single Bullnose

ITEM	Width of Cut-Out	Tread Depth	Bullnose
B6303	48"	11 1/2"	12 1/4"
B6305	60"	11 1/2"	12 1/4"



Double Bullnose

ITEM	Width of Cut-Out	Tread Depth	Bullnose
B6356	42"	11 1/2"	24 1/2"
B6358	48"	11 1/2"	24 1/2"

Above starting steps accommodate Volutes and Turnouts in rail profiles B5100, B5400, B5226, B5700 & B5900 and with Volute for B5500. Also use these steps for all climbing volutes.

8 $\frac{7}{8}$ " Radius - use with Box Newels



Single Bullnose

ITEM	Width of Cut-Out	Tread Depth	Bullnose
B6263	48"	11 1/2"	12 1/4"
B6265	60"	11 1/2"	12 1/4"



Double Bullnose

ITEM	Width of Cut-Out	Tread Depth	Bullnose
B6281	42"	11 1/2"	24 1/2"
B6283	48"	11 1/2"	24 1/2"
B6285	60"	11 1/2"	24 1/2"

Above starting steps are for use with BOX NEWELS and any rail.

7" Radius - use with Box and Square Top Newels and 90° Starting Fittings



Single Bullnose

ITEM	Tread Width	Tread Depth	Bullnose
B6233	48"	11 1/2"	10 1/2"
B6433	48"	14"	10 1/2"
B6633	60"	16"	10 1/2"



Double Bullnose

ITEM	Tread Width	Tread Depth	Bullnose
B6251	42"	11 1/2"	21"
B6253	48"	11 1/2"	21"
B6255	60"	11 1/2"	21"
B6453	48"	14"	21"
B6653	48"	16"	21"

Use B6233, B6251, B6253, B6255 with Box Newels or when using a square top newel on the 2nd riser. Use B6433, B6453, B6633 and B6653 with fittings that have a 90 degree up-easing attached. B6433 & B6453 are used with B5200, B5208, B5000, B5310 volutes and turnouts and B5500 & B5100 turnouts. B6633 & B6653 are used with B5100 & B5500 volutes and B5400, B5226, B5700 & B5900 with volutes and turnouts.

Bowed Starting Steps - use with Volutes and Turnouts



Single Bullnose



Double Bullnose

ITEM	Width of Cut-Out	Bullnose	Bowed Treads are 11 1/2" and project to 14 1/2" at center.	ITEM	Width of Cut-Out	Bullnose
B6703	48"	9 3/4"		B6758	48"	19 1/2"



Above starting steps accommodate Volutes and Turnouts in rail profiles B5200, B5208, B5000, B5310 and with Turnouts for B5500

TREADS: 10 1/2", 11 1/2", 13 1/2"

Treads are 1 1/16" thick. Available in Lengths: 36", 42", 48", 54", 60", 72" and Lineal.



Plain Tread - Nosed

Mitered Return Treads
Specify Right or Left Hand
(RH pictured)

Mitered Returns 2-Ends
Specify the distance between
the returns.

Winder tread blanks are available (not pictured)

RISERS



Risers
Available in 3/4" x 7 1/2"
or 3/4" x 8"

LANDING TREADS



B8090-3 (3 1/2" L)



B8090-5 (5 1/2" L)

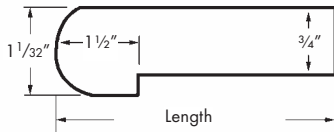

RETURN NOSING



B8080
1 1/16" x 1 1/4" LF
1 1/16" x 1 1/4"-13"

COVE MOULDS



BB100
1 1/16" x 1 1/16"

BB8095
5/8" x 13/16"

SHOE MOULD



BB129
7/16" x 1 1/16"

TREAD MOULD



B8077
1 1/4" x 1 13/16"

BENDABLE LANDING TREADS



B8090-5B
5 1/4" L

B8090-6B
6 1/2" L

FALSE END STARTING STEPS, TREADS & RISERS

Reversible



False End Starting Step

B6203-2
6 1/4" radius

B6303-2
7 3/16" radius

False End starting steps and treads are used when carpeting the center of the stairs. Use B6203-2 or B6303-2 when using a turnout or a volute.



B8079
False End Kit
- Unassembled

False End Tread with Return
(Specify LH or RH)



B8071-LH

B8071-RH

DIMENSIONS: Inside 5 1/4" x 12 3/4"
Outside 6 1/2" x 14"

False End Tread



B8072

DIMENSIONS: Inside 6" x 11"
Outside 6" x 12 1/4"

False Riser



B8076
5 1/4" x 8"

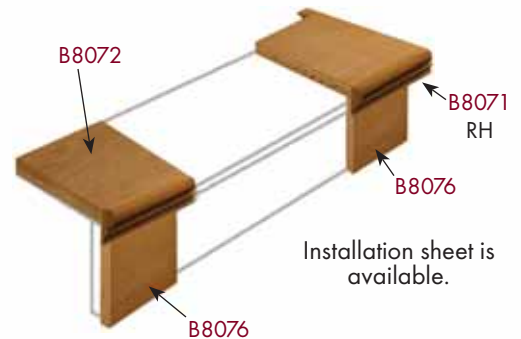

Installation sheet is available.

SURE-TITE™ B3008 Newel Fastening System

- Contains:
1-11" lag bolt
1 washer
1 nut
2 plugs (1 oak
and 1 poplar)

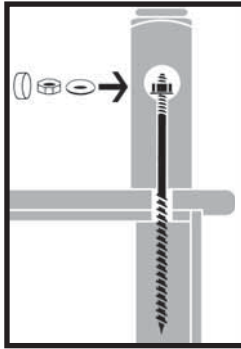

- Uses floor joists for support
- No additional framing needed
- Installs in as little as 10 minutes
- Needs no mortising or coping
- Will not loosen over time
- Exceeds stair code strength requirement.
- Tools Required
Drill Bits: 3/8", 5/8", 1 1/2"
Box End Wrench: 3/4"

Newel Post Fasteners

B3009 and B3019 L-Brackets come with 4 super heavy-duty extruded brackets, 28 hardened screws and mitered trim. Specify 3009 for 3" newels and 3019 for 3 1/2" newels. Available in Red Oak, Poplar, Maple and Cherry.



Threadlock™ B3070 Newel Post Fastener

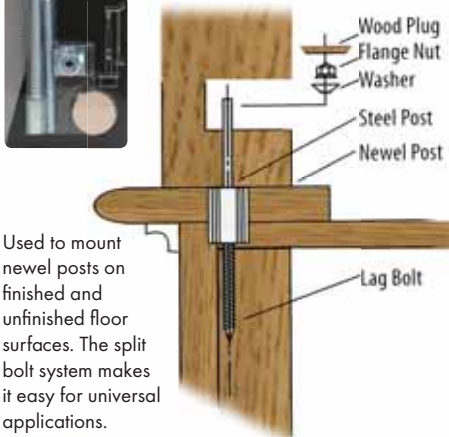

Used to mount newel posts on finished and unfinished floor surfaces. The split bolt system makes it easy for universal applications.

Newel Kit B-3004

1. Locate center of newel on floor. Drill 5/8" hole in to the floor a min. of 1 1/4" deep.
2. Install the 2 hex-nuts on to the installer bolt and lock them together leaving at least 1/4" of threads exposed on the end of the bolt to receive the steel insert. Thread the steel insert on to the installer bolt until the steel insert lightly contacts the hex nuts.
3. Install the steel insert into the floor (min. of 1/8" under fin. Floor). Remove the installer bolt. Remove the 2 hex nuts from the installer bolt and install them on to the 5" hanger bolt locking them together.
4. Drill a 5/16" pilot hole in the bottom of the newel. Remove hex nuts.
5. Thread the newel into the steel insert. Use construction adhesive under the newel during final assembly.

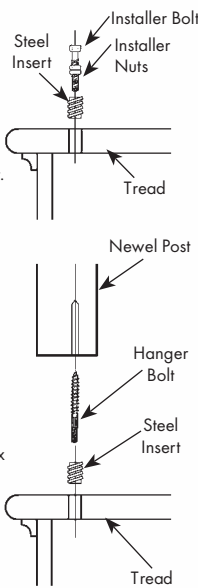

Keylock™ Newel Fastener B-3005

- Includes:
1 - 3/8" x 5" Lag Bolt
1 - 3/8" x 1 7/8" x 2 5/8"
Steel Inlet Plate
4 - #10 x 3 3/4" Wood Screws



Baluster Fasteners

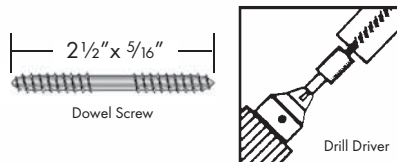

- B3076 - Dowel Screws in quantity of 50
DS2501 - Individual Dowel Screw
B3033 - Drill Driver for Dowel Screws

Buttons & Plugs

- B6403 - 3/8" Button
B6404 - 1/2" Button
B6410 - 1" Button
B6803 - 3/8" Flat Head Plug
B6804 - 1/2" Flat Head Plug
B6810 - 1" Flat Head Plug
B6811 - 1 1/2" Flat Head Plug

Rail Bolt with 1" Plug

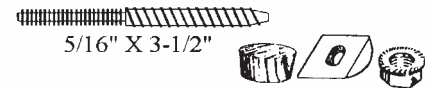

- B6805 - Rail Bolt with washer, nut and plug
B3032 - Rail Bolt Drill Driver

Rail Bolt Installer B92

Install Lag into
Rail, Post, or
Fitting.

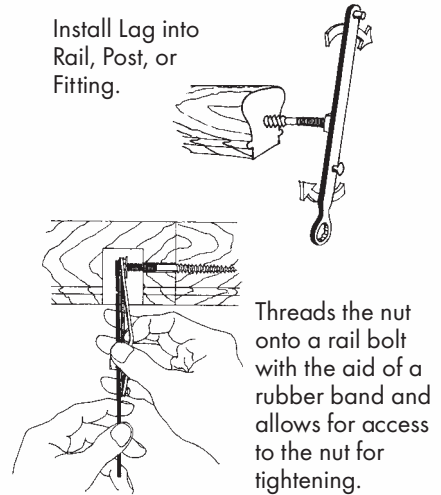

Threads the nut onto a rail bolt with the aid of a rubber band and allows for access to the nut for tightening.

Newel Mounting Plate

Fits 3" to 3 1/2" Square Newels

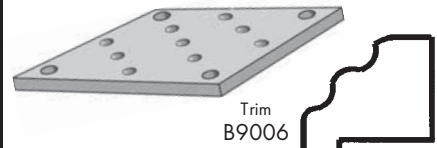

- B3006 - Plate with Trim* and Screws
SNMP4 - Plate only with screws
B9006 - Trim Only 1 1/8" x 1 1/16"

*Trim available in Oak, Poplar, Cherry, Maple

Hand Rail Brackets

Brackets are available in all popular finishes.



HR4235
Wall to rail center
line 2 3/8".

- For Solid Brass specify HR059B.
- For 3 1/2" projection specify HR312.

HR601
Wall to rail center
line 2 3/4".

NOTE: See page 39 for powder coated brackets with a 3/4" center line.